

Tolerable Fire Risk Criteria for Hospitals

Fredrik Olsson

**Department of Fire Safety Engineering
Lund University, Sweden**

**Brandteknik
Lunds tekniska högskola
Lunds universitet**

Report 3101, Lund 1999

**Tolerable Fire Risk Criteria
for Hospitals**

Fredrik Olsson

Lund 1999

Tolerable Fire Risk Criteria for Hospitals

Fredrik Olsson

Report 3101

ISSN: 1402-3504

ISRN: LUTVDG/TVBB--3101--SE

Number of pages: 46 + Appendixes

Cover and figures: Fredrik Olsson

Keywords

Quantitative risk analysis, fire, evacuation, hospitals, tolerable criteria, societal risk, performance-based regulations, event tree technique, risk, qualitative design review, health care facilities, fire safety design.

Abstract

The aim of this study was to establish tolerable fire risk criteria for hospitals. The event tree technique was used to assess the safety level in a model hospital building. Risk profiles were derived and tolerable criteria established by evaluating the risk. The motivation behind this methodology is that buildings designed completely in accordance with today's regulations must be considered safe by society. A representative hospital geometry was equipped with three different fire safety designs, all complying with performance-based regulations. A standard method for the application of fire safety engineering principles when designing fire protection in buildings is presented. An extensive quantitative risk analysis has been carried out. The probability and consequences of each sub-scenario have been calculated by analysing fire development and the evacuation process.

© Copyright: Department of Fire Safety Engineering, Lund University, Lund, Sweden 1999.

Brandteknik
Lunds tekniska högskola
Lunds universitet
Box 118
221 00 Lund

brand@brand.lth.se
<http://www.brand.lth.se>

Telefon: 046 - 222 73 60
Telefax: 046 - 222 46 12

Department of Fire Safety Engineering
Lund University
P.O. Box 118
SE-221 00 Lund
Sweden

brand@brand.lth.se
<http://www.brand.lth.se/english>

Telephone: +46 46 222 73 60
Fax: +46 46 222 46 12

Contents

	SUMMARY	
	SAMMANFATTNING	
	NOMENCLATURE	
1	INTRODUCTION	1
1.1	Background	1
1.2	Objectives and applications	1
1.3	Methodology	2
1.4	General limitations	2
1.5	Acknowledgements	2
1.6	Overview	3
2	QUANTITATIVE RISK ANALYSIS METHODS	5
2.1	General introduction	5
2.2	Risk measures	5
2.3	Standard quantitative risk analysis	7
2.4	Risk evaluation and criteria	7
2.5	A discussion on the establishment of tolerable risk criteria	9
3	FIRE SAFETY DESIGN PROCESSES	11
3.1	A standard engineering approach to fire safety in buildings	11
3.2	Qualitative design review	13
3.3	Quantitative analysis	13
3.4	Assessment vs. criteria	15
4	FIRE PROTECTION IN HOSPITALS	17
4.1	The ideal hospital	17
4.2	Prerequisites and difficulties	17
4.3	Previous fires at hospitals	18
4.4	Statistics and probabilities	20
5	SWEDISH BUILDING REGULATIONS	21
5.1	General regulations	21
5.2	Hospital-specific regulations	25
6	QUALITATIVE DESIGN REVIEW	26
6.1	Review of architectural design	26
6.2	Building, environment and occupant characterisation	26
6.3	Fire safety objectives	28
6.4	Evacuation strategy	28
6.5	Acceptance criteria	28
6.6	Identification of fire hazards	29
6.7	Fire safety designs	29
6.8	Fire scenarios for analysis	30
6.9	Method of analysis	31
7	QUANTITATIVE ANALYSIS	32
7.1	Event trees	32
7.2	Events	32
7.3	Fire development	35
7.4	Evacuation	36
7.5	Assessment vs. criteria	37

8	RISK EVALUATION	41
8.1	Fire safety design 1 – standard protection	41
8.2	Fire safety design 2 – active protection	42
8.3	Fire safety design 3 – alternative active protection	42
8.4	Conclusions	42
9	TOLERABLE RISK CRITERIA.....	45
9.1	Deriving tolerable criteria.....	45
9.2	Limitations.....	46
9.3	Future use of the results.....	46
10	REFERENCES.....	47

APPENDIXES

A	DRAWINGS
B	EVENT TREES FOR FSD1, FSD2 AND FSD3
C	FIRE DEVELOPMENT AND EVACUATION CALCULATIONS
C-1	FSD1 and the nursing room fire
C-2	FSD2 and the cafeteria fire
C-3	FSD3 and the staff room fire

Summary

The use of risk-based fire safety design is becoming getting more common, but the lack of established tolerable fire risk criteria makes it difficult for the designer to determine whether his building is safe or not. The objective of this project was to quantify a tolerable fire risk for hospitals, thus providing society with a measure on the risk, i.e. safety level, that is acceptable for hospitals, when they are designed with the aid of calculations.

A representative hospital building geometry was chosen for the analysis. By providing this building with a number of different fire protection solutions, a number of fictive hospitals were created in which the geometry was the same but the fire protection varied. The building and its installations comply with the mandatory provisions and general recommendations given in Swedish performance-based building regulations.

A standard method for the application of fire safety engineering principles when designing fire protection in buildings is presented. The method consists of three steps. In the first step a qualitative design review is performed in which the building, its environment and its occupants are characterised. Fire safety objectives, evacuation strategy and acceptance criteria are established. Trial fire safety designs and fire scenarios are proposed. The second step involves a quantitative analysis in which fire hazards are calculated and the evacuation process estimated. The safety of the building is calculated by regarding the assessment in comparison with the criteria. In the third and final step, the risk is evaluated and appropriate measures suggested.

In the quantitative analysis, a so-called event tree technique was employed where an initial event results in a number of sub-scenarios, depending on the outcome of each event. Fire is chosen as the initial event and the sub-scenarios are formed when considering the function of fire protection installations and the staff response. Three fire scenarios and three fire safety designs were included in the analysis forming the event trees with a total of 270 sub-scenarios. The fire scenarios are the patient's room fire, the staff room fire and the cafeteria fire. The fire safety measures were standard protection with smoke detectors, active protection with sprinklers and an alternative active protection system including with smoke barriers and a system for staff back-up.

The probability and the consequence are calculated for each sub-scenario. Finally, the risk is presented as a risk profile where the number of people exposed to critical conditions are compared with the cumulative frequency of occurrence. Analysis and evaluation of the calculated risk profiles derive the tolerable fire risk criteria. The motivation behind this methodology is that buildings designed completely in accordance with today's regulations must be considered safe by society. An important finding of this study is that today's regulations do not provide sufficient safety in the case of fire at hospitals. This is mainly due to the fact that patients are not usually able to evacuate by themselves. The patient to staff ratio is therefore crucial when discussing fire safety at hospitals.

The results of this study will be of great use in the future when evaluating safety levels of new or modernised hospitals as well as when comparing future established risk criteria for other building types. The study will also provide politicians and officials with an idea on the safety level afforded by today's regulations.

This report is part of the project, "Design Based on Calculated Risk" which is supported by The Swedish Fire Research Board (BRANDFORSK) and The Development Fund of the Swedish Construction Industry (SBUF).

Sammanfattning

Dimensionering efter beräknad risk blir allt vanligare. Men avsaknaden av fastställda kriterier för tolerabel risk gör att projektören har svårt att avgöra om hans byggnad är tillräckligt säker. Målsättningen med detta arbete är att kvantifiera tolerabel risk för sjukhus. Syftet är att presentera ett mått på den säkerhetsnivå som samhället anser vara accepterad för sjukhus då dessa dimensioneras genom beräkning.

En representativ sjukhusgeometri väljs för analysen. Genom att förse denna byggnad med olika brandskyddslösningar skapas ett antal fiktiva sjukhus, där geometrin är den samma med skyddet varierar. Byggnaden och dess installationer uppfyller alla de ”skall” och ”bör” som återfinns i de funktionsbaserade byggreglerna, BBR 99.

En standardmetod för hur man skall tillämpa ingenjörsvetenskap vid dimensionering av brandskydd i byggnader presenteras. Denna metod omfattar tre olika steg. Först skall en designgenomgång utföras där byggnaden, miljön och innevanorna karakteriseras. Brandskyddsmål, utrymningsstrategi och acceptanskriterier skall definieras. Förslag på brandskyddslösning och de brandscenarion som skall undersökas presenteras. I det andra steget genomförs en kvantitativ analys av brandförlopp och utrymningsprocess. Genom att värdera resultatet mot de acceptanskriterier som fastställts beräknas byggnaden säkerhet. Som ett tredje och sista steg utvärderas risken och lämpliga åtgärder vidtas.

Den kvantitativa riskanalysen använder sig av händelseträdsteknik, där en inledande händelse formar ett antal delscenarier, beroende på vad som händer på vägen. Som inledande händelse väljs brand och delscenarierna formas då det tas hänsyn till de olika brandtekniska installationernas funktion och personalens agerande. I analysen inkluderas tre olika brandskyddslösningar och tre brandscenarier som tillsammans ger 270 delscenarier. Brandscenarierna omfattar brand i vårdrum, personalrum och cafeteria. De tre brandskyddslösningarna är standard brandskydd med rökdetektorer, aktivt brandskydd med sprinkler och ett alternativt aktivt brandskydd med rökavskiljning kompletterat med ett larmsystem ger personalförstärkning i händelse av brand.

Sannolikheten och konsekvensen beräknas för varje delscenario. Slutligen presenteras risken med hjälp av en riskprofil där antalet som utsätts för kritiska förhållanden sätts mot den ackumulerade frekvensen för att det inträffar. Tolerabelt riskkriterium tas fram genom att analysera och utvärdera de beräknade riskprofilerna. Det främsta argumentet för användandet av denna metodik är att byggnader som uppförs helt i enlighet med de regler och normer som finns, måste anses ha en säkerhetsnivå som anses vara tolerabel av samhället. Ett resultat av studien är att dagens byggregler inte ger tillräcklig personsäkerhet i sjukhus. Detta beror i huvudsak på att flertalet patienter inte kan utrymma utan vårdpersonalens hjälp. Kvoten mellan antalet patienter och vårdare är därför mycket betydelsefull för säkerheten på sjukhus.

Detta är ett pionjärarbete när det gäller tolerabel risk och metoden kommer förhoppningsvis att utvärderas och användas för att ta fram tolerabel risk för andra byggnadstyper och aktiviteter. Resultat kommer till stor nytta i framtiden för att kontrollera säkerheten vid ny- eller ombyggnad av sjukhus, samt vid jämförelse med andra riskkriterier. Arbetet kommer förhoppningsvis också att ge politikerna en uppfattning om vilken säkerhetsnivå som dagens regler ger. Rapporten ingår som en del i projektet ”Dimensionering efter beräknad risk, vilket stöds av Brandforsk och Svenska byggbranschens utvecklingsfond (SBUF).

Nomenclature

α	Fire growth factor, kW/s ²
A	Floor area, m ²
ASET	Available Safe Egress Time
D	Distance to exit, m
f	Flow factor of the door opening expressed as people / (m s)
F	Frequency, often expressed as times per year
M	Evacuation safety margin
No	Number of people
No _{pat}	Number of patients to be evacuated
No _{staff}	Number of staff present to assist evacuation
P _{fire}	Probability of one fire starting per year
RHR	Rate of Heat Release, kW
t _{care}	Time taken (s) for the staff to prepare the patient for evacuation
t _{critical}	Time taken (s) to reach critical, i.e. untenable, conditions
t _{detection}	Detection time (s), either automatic or manual
t _{evacuation}	Evacuation time, s
t _{patM}	Time taken (s) for the patient to move to safe area
t _{queue}	Queuing time, s
t _{reaction}	Reaction time, s
t _{staffM}	Time taken (s) for the staff to move to the patients
t _{travel}	Travel time, s
t _{walk}	Time taken (s) for people to walk to the safe area
v	Walking speed of evacuating people, m/s
W	Width of door opening, m

1 Introduction

This report is the final project carried out in the Bachelor of Science degree programme in Fire Protection Engineering at Lund University, Sweden. The project has been carried out in close co-operation with Sycon, consulting engineers in Malmö, Sweden. The report is part of the project "Design Based on Calculated Risk" which is supported by The Swedish Fire Research Board and The Development Fund of the Swedish Construction Industry (SBUF). The Swedish Fire Research Board is a joint state, municipal and industrial organisation for the initiation, funding and control of research within the field of fire safety.

1.1 Background

The introduction of performance-based building regulations in Sweden in 1994 has resulted in a number of benefits. These regulations led to the development of new solutions in fire protection. They provide better flexibility and means of implementation for each individual building. They have also led to a lowering of the total cost of fire protection installations, without compromising the safety level.

However, following the transition to performance-based regulations, the uncertainty as to whether a building is safe or not has increased. According to an evaluation performed by the Swedish Board of Housing, Building and Planning (Boverket, 1997), the uncertainty in safety level does not depend on the regulations. One of the problems is that methods for design have not been completely adopted by consultants. It is therefore necessary to continue the work on fire safety design based on calculations e.g. design by calculated risk.

Terms like "good" or "bad" in describing the safety level of building are not appropriate. These terms are subjective and non-quantitative. Those who design fire protection measures should be able to present a more quantitative measure of the safety level. The Department of Fire Safety Engineering at Lund University is involved in extensive research within the area of the fire and risk. One of the research projects, "Fire Safety Design Based on Calculations" has the objective of producing an event tree based model for risk analysis in buildings. Such a model has two primary uses; it can be used to verify whether a building fulfils the criteria for accepted risk, and it can be used to derive the combination of fire safety measures leading to the lowest cost for the accepted risk.

Risk can be defined as the correlation between the frequency of an activity's possible failures and the consequences resulting from those failures. Using this definition, risk can be expressed as a risk profile, where the risk is illustrated by a so-called FN curve (Frequency of accidents vs. Number of fatalities.). Attempts are being made to establish acceptable risk criteria for different types of buildings such as hotels, health care facilities, shopping centres, etc.

1.2 Objectives and applications

The main objective of this project was to quantify a tolerable risk for hospitals. This should provide society with a measure on the risk, i.e. safety level, which is acceptable in hospitals, when they are designed by calculations. Another objective was to determine which parameters are of importance for the safety level of a hospital.

One application of the results of this work is in designing buildings in the future, when the acceptable risk profile could be used to guide the fire safety consultant in designing a safe building. By applying this methodology, it is possible to determine which installations actually increase personal safety in the building. The methodology could also be used to analyse the cost and benefit of fire protection installations.

1.3 Methodology

A representative hospital building geometry was chosen for analysis. By providing this building with a number of different fire protection solutions, a number of fictive hospitals were created in which the geometry was the same but the fire protection varied. The building and its installations must fulfil the demands laid out in the regulations. An event tree based risk analysis model was used to calculate the risk profiles for the hospitals. Finally, these risk profiles were combined to obtain a measure of the tolerable risk profile for hospitals.

The methodology can be divided into three main stages.

1. Different methods and principles for fire safety design based on calculations and risk evaluation were studied. The representative hospital was chosen and three fictive hospitals were constructed, all with different fire protection solutions.
2. A model for event tree based risk analysis was chosen and risk analyses for the three hospitals were carried out. The results are expressed in terms of risk profiles.
3. To establish the tolerable risk criteria for hospitals the risk profiles were evaluated. The future use of the model is discussed.

1.4 General limitations

The Swedish building regulations state that a building shall be designed so that satisfactory escape can be effected in the event of fire. The conditions in the building shall not become such that the limiting values for critical conditions are exceeded during the time needed for escape (Section 5.1.3). The risk profile gives no information on the number of fatalities. Available research does not present precise and quantitative criteria for the calculation of fatalities in a fire. Instead, the number of people exposed to critical conditions replaces the number of fatalities. Naturally, escape is in some way possible even after critical conditions have been reached.

This way of describing risk is in complete accordance with common ways of expressing societal risk. The calculated FN curves could therefore not be used to compare societal risk for different activities. Its use is limited to the comparison of safety levels between different buildings and to compare the effects of different fire protection installations. This study only involves only one building geometry. The results may therefore not be valid for hospitals whose layout does not correspond to the geometry chosen here.

1.5 Acknowledgements

I would like to express my great gratitude to my academic tutor Dr. Håkan Frantzich, at the Department of Fire Safety Engineering, Lund University and to fire protection engineer Fredrik Jörud at Sycon, who initiated the project and provided helpful support.

1.6 Overview

Quantitative risk analysis methods are discussed in Chapter 2. Various risk measures as well as methods of risk evaluation are presented. Arguments on the establishment of tolerable risk are discussed. The chapter also gives a brief introduction to standard quantitative risk analysis.

The *fire safety design process* is illustrated in Chapter 3. A discussion on different fire safety design methods is presented. The methodology presented in “Fire safety in buildings – a guide to the application of fire safety engineering principles” presented by the British Standards Institution, BSI (1997) is used.

Fire protection in hospitals, different approaches, difficulties and prerequisites are analysed in Chapter 4. Conclusions are drawn from previous hospital fires. Fire-related statistics and probabilities are presented. This chapter is of great importance in understanding the particular conditions for fire protection in hospitals.

Swedish building regulations are presented in Chapter 5 in order to give the reader a complete picture of the fire safety design process. Both general and hospital-specific regulations for safety in the case of fire are given.

In Chapter 6, a *qualitative design review* is performed for the hospital chosen for analysis. The building, its environment and its occupants are characterised. Fire safety objectives, evacuation strategy and acceptance criteria are established. The chapter also presents the three fire safety design solutions as well as the fire scenarios analysed.

The *quantitative analysis* is presented in Chapter 7. Event trees are defined, fire hazard calculated and the evacuation process estimated. By plotting assessment against criteria, risk profiles are constructed for each of the three fire safety designs.

Risk evaluation is presented in Chapter 8. Parameters with the greatest influence on fire safety are identified. Different risk reducing measures are presented and a brief summary is given.

Tolerable risk criteria are established in Chapter 9. A proposal for upper and lower limits for risk tolerance is given, and the ALARP zone is defined. The limitations of the method are discussed in general.

2 Quantitative Risk Analysis Methods

2.1 General introduction

This report uses the definition of risk and risk management adopted by the International Electrotechnical Commission (IEC, 1995). The activities in the risk management process are stated in the figure below.

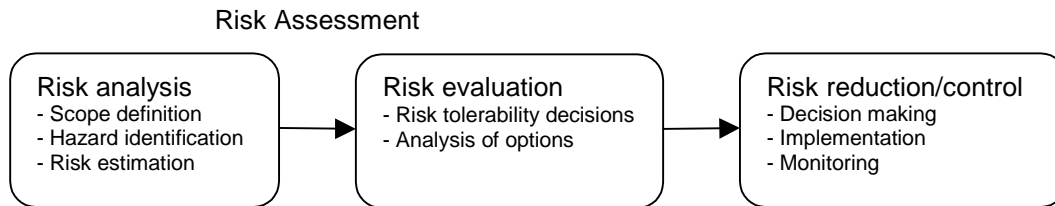

Figure 2.1 A simplified relationship between risk analysis and other risk management activities.

Risk management can be considered as being the complete methodology that contains both qualitative and quantitative analysis methods. Risk management can be divided into three different steps. It is first necessary to calculate the risk by performing a risk analysis where systems are defined, hazards calculated and the risk estimated. Then the risk must be evaluated. These two steps can be called risk assessment. The final step is to take appropriate measures to reduce and/or control the risk.

In the CPQRA (1989) risk is defined as a measure of economic loss or human injury in terms of both the likelihood and the magnitude of the loss or injury. The IEC (1995) defines risk as a combination of the frequency, or probability, of occurrence and the consequence of a specified hazardous event. Note that the concept of risk always has two elements: the frequency or probability with which a hazardous event is expected to occur and the consequences of the hazardous event.

Two quantitative risk analysis (QRA) methods can be used to quantify the risk to occupants in for example, a building in which a fire has broken out. The extended QRA considers the inherent uncertainty in the variables explicitly. The standard QRA does not consider uncertainties in the variables and must therefore be accompanied by a sensitivity analysis or an uncertainty analysis (Frantzich, 1998). Both methods provide risk measures such as individual risk and FN curves.

2.2 Risk measures

Risk can be expressed as individual risk or as societal risk. These are the two most frequently used risk measures. Individual risk measures consider the risk to an individual who may be at any point in the effect zones of incidents, while societal risk measures consider the risk to populations that are in the effect zones of incidents. In this report the effect zone is the analysed hospital building.

The CPQRA (1989) gives the following illustrative example of the difference between individual and societal risk.

An office building is located near a chemical plant and contains 400 people during office hours and one guard at other times. If the likelihood of an incident causing a fatality at the office building is constant throughout the day, each individual in that building is subject to a certain individual risk. This individual risk is independent of the number of people present – it is the same for each of the 400 people in the building during office hours and for the single guard at other times. However, the societal risk is significantly higher during office hours, when 400 people are affected, than at other times when a single person is affected.

In this report the societal risk measure will be used to express the risk. Therefore, the individual risk measure will only be discussed very briefly.

2.2.1 Individual risk

Individual risk is defined as the risk to a person in the vicinity of a hazard. This includes the nature of the injury to the individual, the likelihood of the injury occurring, and the time period over which the injury might occur. In a building, the individual risk differs depending on where the individual is and what action he takes. In a hospital, in the case of fire, the individual risk is higher if the individual is unable to evacuate unaided. At a chemical plant, the individual risk is lower for someone working in the office some hundred metres away from the plant, than for the workers involved in production. Individual risk is often expressed as the likelihood of injury per year and has the same value around the clock.

2.2.2 Societal risk

Many major incidents have the potential to affect many people. Such incidents are, for example a fire or leakage of a hazardous chemical substance. The societal risk measures risk to a group of people, e.g. those in a certain building. The most common way of expressing societal risk is an FN curve, where the frequency of an incident is plotted versus the number of fatalities for that specific incident. The FN curve is the exceedance curve of the probability of the event and the consequences of that event in terms of the number of deaths. The curve shows the probability (cumulative frequency) of consequences being worse than a specified value on the horizontal axis. Figure 2.2 shows an example of an FN curve.

The risk is defined from the societal point of view. Authorities do not usually accept serious consequences, even with low probabilities. Therefore the societal risk measure can be used to define tolerable risk criteria for different activities.

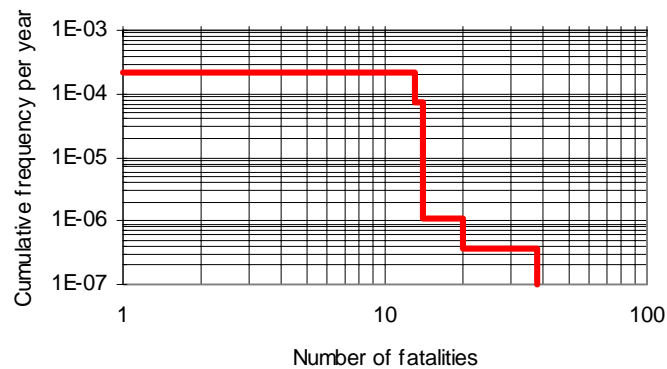

Figure 2.2 A fictive example of an FN curve.

When performing a risk analysis for the case of fire, today's methods do not provide sufficient information to calculate the number of fatalities. Instead, a measure of the number of people who will be exposed to critical, i.e. untenable, conditions will be used. The definition of critical conditions will be discussed in Section 5.1.3.

2.3 Standard quantitative risk analysis

A preferable way of performing a quantitative risk analysis in the area of fire safety engineering is to use event tree analysis (Section 3.3). Event tree analysis can take into account human behaviour and the reliability of installed fire protection systems. In the chemical process industry and in nuclear power plants, the standard QRA is most frequently used to describe risk. In fire safety engineering the standard QRA is used, for example, to compare different design solutions.

The standard QRA is based on a high number of deterministic sub-scenario outcome estimates, but the method is still considered probabilistic. When a large number of sub-scenarios is considered, each with its individual probability, this will lead to a probabilistic measure of the risk (Frantzych, 1998).

The FN curve from a standard QRA can be used to compare different design solutions or to determine whether or not the design complies with tolerable risk levels. Tolerable risk is discussed in more detail later in this chapter.

2.4 Risk evaluation and criteria

When a risk analysis has been performed for a given activity, and the calculated risk has been considered tolerable, it is important to discuss "who is the risk tolerable"? If you have an economic interest in an activity you are likely to accept higher risks than if you are one of those personally affected by the risk. Another element of importance in the evaluation of risk is whether you are affected by the risk yourself or not. A risk could be tolerable from a societal point of view, but we all think that others should carry it.

The risk perception of today's society is complex. Some carry out high-risk activities voluntarily, e.g. smoking and mountain climbing, while we are very reluctant to accept other risks. Such a risk may be the establishment of a new process industry in our neighbourhood.

Decisions in risk matters must be based on a common public opinion, using objective judgement, keeping public as well as individual interests in mind.

Risk can be evaluated and risk criteria established using four different principles (Det Norske Veritas, 1997). *The principle of reasonableness* says that an activity should not involve risks that by reasonable means could be avoided. Risk that by technically and economically reasonable means could be eliminated or reduced are always taken care of, irrespective of the actual risk level. *The principle of proportionality* means that the total risk that an activity involves should not be disproportionate to its benefits. By using *the principle of distribution*, risks should be legitimately distributed in society, related to the benefits of the activity involved. Single persons should not be exposed to disproportionate risk in comparison with the advantage that the activity affords them. *The principle of avoiding catastrophes* says that it is better that risks are realised in accidents with a lower number of fatalities. When discussing risk reduction, terms such as *ALARP* (As Low As Reasonably Practicable) and *ALARA* (As Low As Reasonable Achievable) are frequently used.

The tolerable risk can be defined as limit lines in the FN diagram (Figure 2.3). Risks that are below the lower line are tolerated and they do not have to be reduced. Risks in the zone between the two lines are in the tolerable ALARP area. Risks in this zone should be reduced if it is practicable and does not involve disproportionate costs. Risks that are above the upper line are not tolerable and should be subjected to a risk reduction process.

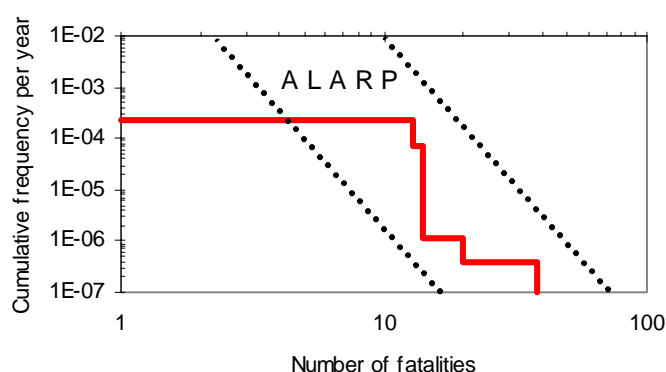

Figure 2.3 The tolerable risk is illustrated as the ALARP zone between the two dotted lines.

Tolerable risk levels have been developed for some large infrastructures in a number of countries. In Sweden no such general tolerable risk criteria have been established by society. One of the objectives of this report is to present such a measure. In a report commissioned by the Swedish Rescues Services Agency, Det Norske Veritas (1997) gives a proposal for tolerable societal risk criteria to be used when weighing assessment against criteria in a risk analysis. The proposal is given as an FN curve, where a grey zone is used to outline risks that could be tolerated. The proposal is illustrated in Figure 2.4.

The FN curve has the following specification:

- Upper limit for risk tolerance is $F = 10^{-4}$ for $N = 1$.
- Lower limit where risks are considered low is $F = 10^{-6}$ for $N = 1$.
- The elevation of the limit lines is -1 .
- There is no upper limit for possible consequences.

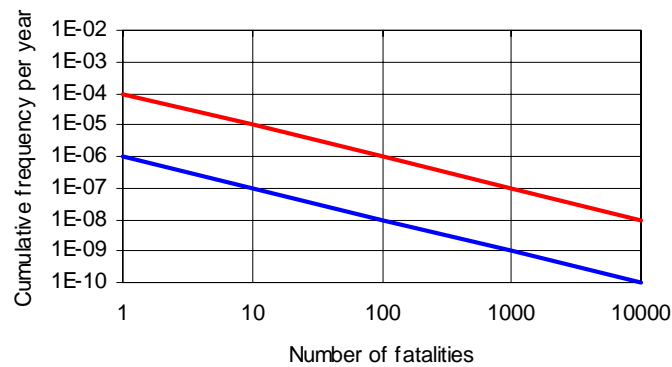

Figure 2.4 Det Norske Veritas proposal for tolerable societal risk criteria.

Det Norske Veritas proposal does not differ significantly from that in other countries.

This report uses the same definition of an unwanted event as that presented by Frantziach (1998). An unwanted event is defined as the case when people are unable to escape the threat of a fire within the available escape time. The available escape time is defined by the time taken to reach critical levels of untenable conditions. Therefore, the more general term, risk profile, will be used to represent the societal risk instead of the term FN curve, which is frequently used for activities other than fire. In a risk profile, the number of people exposed to critical conditions is shown on the X-axis, instead of the number of fatalities.

2.5 A discussion on the establishment of tolerable risk criteria

As stated before, the main objective of this report is to find a way of establishing tolerable risk criteria for hospitals. In order to do so a number of questions must be discussed:

- When is a risk considered tolerable?
- Are there any differences in risk perception and risk reluctance at a hospital?
- How is it possible to quantify a tolerable risk?

It is believed that a risk is considered tolerable only when society accepts it. Risk communication is a complicated matter and should not be ignored. Perhaps there should be a higher risk reluctance at hospitals as the patients are often “helpless” and under the responsibility of the hospital staff. Risk communication often fails when a hazardous incident has occurred. These failures are frequently related to differences in the interpretation of risk. The problem can also be related to the fact that methods for risk calculation and risk presentation are not well established, and also that the methods of risk evaluation are not commonly accepted. It is easy to give the risk a value such as one incident per 1000 year, but it is a fact that people react more to how the precipitate the risk than on the actual number. We are therefore more willing to accept the risk of a traffic accident, than the risk of a nuclear power plant breakdown, despite the fact that the number of people killed in traffic accidents far exceeds the number of fatalities in nuclear power accidents. It is the elevation of the limit lines in Figure 2.4 that represents risk aversion. The sharper the elevation the higher the aversion towards risks.

Tolerable risk has been established here by using the following arguments:

- All Swedish buildings are regulated by the Swedish performance-based building regulations (BBR, 1994). This code has been adopted by parliament and is applied to the construction of new buildings as well as renovations.
- The code contains mandatory provisions and general recommendations for building safety in the case of fire.
- Buildings that designed and built exactly according to the regulations must be considered to have a tolerable safety level.

If risk analyses are carried out on buildings that fulfil these regulations, the risk profiles could be used to quantify the tolerable risk criteria.

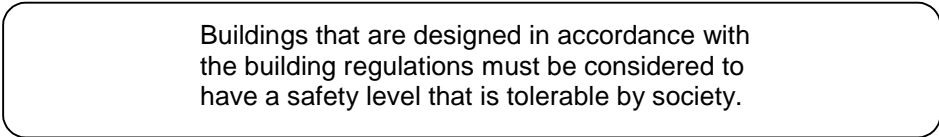

Buildings that are designed in accordance with the building regulations must be considered to have a safety level that is tolerable by society.

Figure 2.5 The main argument for the establishment of tolerable risk criteria

3 Fire Safety Design Processes

There are three main methods of performing fire safety design. These methods are all accepted by regulatory bodies and differ in their degree of detail. The methods are:

- *The standard method*, simple handbook solution, i.e. using former prescriptive regulations
- *The fire safety engineering method*, calculations on sub-levels, e.g. evaluating escape time margin
- *The risk-based verification method*, evaluation on system level with risk analysis, i.e. performing a quantitative risk analysis (QRA)

At the 2nd International Conference on Performance-Based Codes and Fire Safety Design Methods in 1998, “The Swedish Case Study – Different Fire Safety Design Methods Applied on a High Rise Building” (Jönsson & Lundin, 1998) was presented. In that study, a number of different fire safety design solutions were compared in order to find out which solution resulted in the lowest risk related to its cost. Handbook design solutions were compared with fire safety engineering solutions. One of the major conclusions from the study was that the right choice of solution, using the fire safety engineering method, could only be made by using a risk-based verification method in the evaluation process. This was also one of the findings from a recently completed Swedish study (Boverket, 1997), which concluded that misuse of the fire safety engineering method could lead to unsafe buildings. This clearly shows the benefit of and to use a risk-based verification method as a complement to a deterministic engineering method.

If the standard method is used, no calculations are required. But, the standard design solution could be less cost-efficient than other solutions with similar or better safety levels. If the engineer uses the fire safety engineering method he relies upon “the reasonable worst case”. He does not take into account sprinkler or detection failure, etc. The fire safety design method is preferably used when comparing, for example, different detection, suppression or alarm systems, i.e. on a sub-level. The method should not be used for the complete fire safety design system. The risk-based verification is the only method that can be used to completely analyse the consequences of a fire in a building.

3.1 A standard engineering approach to fire safety in buildings

In their Draft for Development No. 240 (1997), the British Standards Institution outlines a framework for an engineering approach to fire safety in buildings. This framework can be used to show that regulatory or insurance requirements can be satisfied. Sections 3.1-3.4 follow the methodology presented by the BSI (1997). The basic fire safety design process consists of four main stages.

- A qualitative design review
- A quantitative analysis
- Assessment against criteria
- Reporting and presentation

This basic process is illustrated in Figure 3.1. The BSI (1997) gives guidance in the application of scientific and engineering principles to the protection of people and property

against fire. The framework presents an excellent approach on how to handle fire safety design issues. Because of its completeness, this framework is highly recommended as a fire engineering guideline.

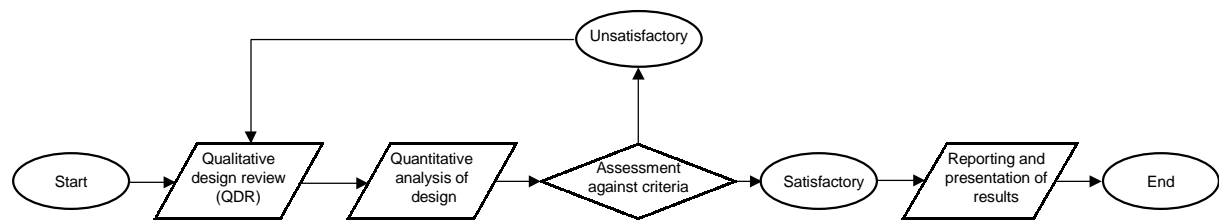

Figure 3.1 The basic fire safety design process.

Fire is a transient process which affects a building and its occupants in different ways at different stages. The process of fire safety design is complicated by the fact that time is one of the key design parameters. As stated by the BSI, it is important when carrying out a quantitative analysis, to recognise the role of time and the interaction of parameters within a consistent time framework. When assessing the number of people exposed to critical conditions a comparison between two time lines is made. One of these time lines represents the course of the fire, in terms of its size, rate of burning and smoke or toxic gas concentration. The other time line represents the response to the fire by the occupants. These time lines and the specific expressions used are presented in Figure 3.2. Note that the expressions differ between different countries.

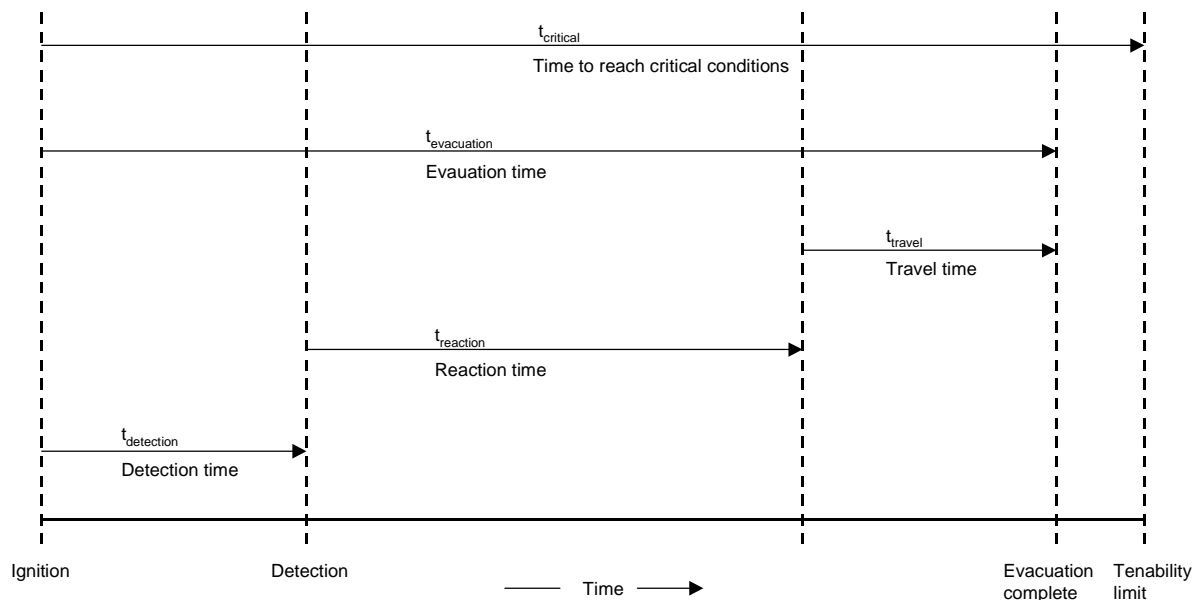

Figure 3.2 Example of a time line comparison of fire development and evacuation.

The fire safety design process begins with a qualitative design review (QDR). During the QDR the scope and the objectives of the fire safety design are defined, performance criteria established and one or more potential design solutions proposed. Key information to be used as input in the quantitative analysis is also gathered. During the quantitative analysis the fundamentals of fire science are applied. The analysis performed using six sub-systems,

which reflect the impact of a fire on people and property at different stages in its development. The sub-systems cover fire growth and development, the spread of combustion products and fire from the source, fire detection and the activation of fire safety systems, fire service intervention and the evacuation of occupants. In performing the quantitative analysis it is necessary to assess the outcome in relation to the established performance criteria. When the report is assembled a minimum amount of information is required. This information consists of, for example, the findings of the QDR, assumptions, references, engineering judgements, methodologies employed, sensitivity analyses and comparison of the results with the performance criteria.

3.2 Qualitative design review

The objective of the QDR is to review the architectural design, identify fire hazards and define the problem in qualitative terms suitable for detailed analysis and quantification. Another important function of the QDR is to establish one or more fire protection trial designs, which are likely to satisfy the fire safety criteria. A team including one or more fire protection engineers should preferably carry out the QDR. It is appropriate that representatives from approval bodies, insurers and operational management are also involved in the QDR. The QDR should include:

- A review of the architectural design
- A characterisation study of the building, environment and occupants
- Fire safety objectives
- An evacuation strategy
- Identification of fire hazards and possible consequences
- The establishment of trial fire safety designs
- A specification of fire scenarios for the analysis

3.3 Quantitative analysis

Following the QDR a quantitative analysis can be carried out. This analysis is divided into six different sub-systems, all describing the impact of a fire on people and property. Each sub-system may be used separately when analysing a particular aspect of design, or they may all be used together in an overall fire engineering approach. The six sub-systems (SS) are:

- SS 1 Initiation and development of fire within the enclosure of origin
- SS 2 Spread of smoke and toxic gases within and beyond the enclosure of origin
- SS 3 Fire spread beyond the enclosure of origin
- SS 4 Detection and activation of fire protection systems
- SS 5 Fire service intervention
- SS 6 Evacuation

Data flow into, out of and between the various sub-systems is described via an information bus. For example, output from SS 1 “Initiation and development of fire within the enclosure of origin” is linked to the other sub-systems as shown in Figure 3.3.

Rate of heat release	→ SS 2, SS 3
Smoke mass	→ SS 2, SS4
Rate of CO mass production	→ SS 2
Fame size	→ SS 4
Time of flashover	→ SS 3

Figure 3.3 Illustration of the links between SS 1 and the other sub-systems via the information bus in the quantitative analysis.

The quantitative analysis may either be deterministic or probabilistic. A more general description of the quantitative risk analysis is given in Chapter 2. A deterministic analysis using the event tree technique to identify the outcome of a fire is very useful. Event trees are logic diagrams, which can be used to illustrate the sequence of events involved in ignition, fire development and control, as well as the course of escape. Figure 3.4 shows an example of a simple event tree for a fire. The risk for each sub-scenario is calculated by multiplying the probability of the sub-scenario by its consequences. The total risk associated with a building is the sum of the risks for all sub-scenarios in the event tree.

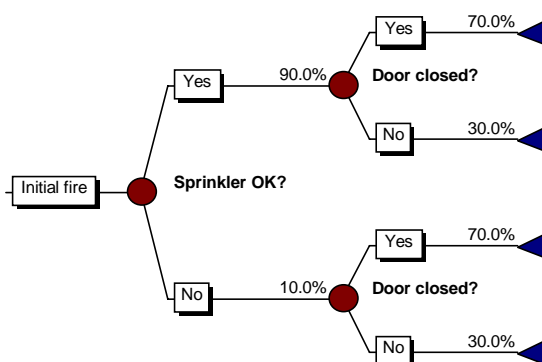

Figure 3.4 Example of part of an event tree.

To produce a definitive measure of the risk to life it would be necessary to consider every combination of fire source, fire scenario and target location within the building. However, the computational effort required increases with the number of sources, scenarios and targets considered. The QDR is used to simplify the problem.

The time elapsed before critical conditions ($t_{critical}$) are reached and the time required for evacuation ($t_{evacuation}$) are calculated within the six sub-systems. $t_{critical}$ depends on fire growth, ceiling height, rate of heat release, ventilation, etc. Hazardous conditions are loss of visibility, exposure to toxic products and exposure to heat. The hazardous conditions are defined in the building regulations. $t_{evacuation}$ depends on detection, reaction and travel times.

3.3.1 Uncertainties and sensitivity analysis

When calculating the time to reach critical conditions and the evacuation time a number of parameters must be defined by a single value each. However, in every risk analysis a number of variables should be considered as random. Fire load and fire growth are examples

of parameters that are difficult to predict with a single value. The engineer has to decide upon a worst credible fire. The best way to deal with uncertainties is to perform an extended QRA (Section 2.1), where variables are described by probability density functions. A sensitivity analysis should examine the following (FEG, 1996):

- Variation of the inputs
- How the magnitude of simplification influences the outcome
- The reliability of technical systems
- The influence of open doors, improper measures, etc.

Using an event tree technique, the sensitivity of many parameters can be evaluated. For example, doors could be left open or closed, escape routes could be blocked, detection systems and sprinklers could fail etc. The event tree could also consider fire development and smoke spread. Although the event tree technique includes sensitivity analysis, the engineer must be very cautious when defining the tree so that all relevant events are incorporated.

3.4 Assessment vs. criteria

Following the quantitative analysis, the results should be compared with the acceptance criteria identified during the QDR. If it is demonstrated that none of the trial fire safety designs satisfies the specific acceptance criteria, the QDR should be repeated until a satisfactory fire safety strategy has been found (Figure 3.1). In a deterministic study the objective is to show that, on the basis of the initial assumptions (usually “reasonable worst case”), a defined set of conditions will not occur.

In a probabilistic study, the criterion set is that the probability of a given event occurring is acceptably low. The event tree approach is based on a high number of deterministic sub-scenario outcome estimates, but the method is still considered probabilistic. When a large number of sub-scenarios are treated, each with its own probability it is possible to derive a probability density function for the consequence, which leads to a probabilistic measure of risk.

The design equation in the case of fire can be expressed as:

$$M = t_{\text{critical}} - t_{\text{evacuation}} \quad [3.1]$$

where M denotes evacuation margin. If $M > 0$ then the design solution is satisfactory. The evacuation time can be described in terms of three separate variables, which describe the evacuation process (Figure 3.2):

$$t_{\text{evacuation}} = t_{\text{detection}} + t_{\text{reaction}} + t_{\text{travel}} \quad [3.2]$$

When M is less than zero, all people are not able to leave the building before critical conditions occur. For the purpose of design, it may generally be assumed that the response of the occupants is unchanged until conditions become untenable, after which movement ceases. Critical, i.e. untenable, conditions are defined in the building regulation (Chapter 5).

4 Fire Protection in Hospitals

Fire safety is one of the greatest challenges facing the designers and operators of health care facilities. This is particularly true where patients are highly dependent on members of staff, for example, the elderly, the mentally ill, those in intensive care units, etc. The lack of alertness, lack of mobility and high dependency on fixed equipment have obvious implications for patient safety in the event of fire (Charters, 1996).

The Swedish National Board of Health and Welfare states in a report a number of conditions that “the good hospital” should fulfil (Socialstyrelsen, 1996). The Board also presents examples of specific safety-related problem areas for hospitals. Fire protection is one of these areas. It is stated in the report that safety is mainly achieved by good fundamental qualities, such as physical design and building construction. Safe solutions should not depend on complex additional installations. For example, it is not suitable to compensate insufficient passive fire protection for fire and smoke control with an active system like sprinklers.

4.1 The ideal hospital

A hospital built as a small town, with spacious planning of buildings and streets in between, is a good example of safety considerations in the planning process. The hospital buildings should have a limited size and a limited number of floors.

In the planning process of hospitals the following should be taken into consideration:

- Escape routes, design and building material
- Design of different rooms, establishments and fire protection measures
- Fire protection installations, fire compartments, smoke ventilation, safety equipment and fire safety design
- Separation by culverts and tunnels
- Atrium difficulties
- The possibility of the fire service to fight a fire
- High-technology safety systems

Apart from normal fire compartmentalisation, large building blocks should be separated into smaller units divided by a number of separators, which prevent fire spread, and control smoke movement. They should also be able to withstand some fire related pressure increase.

4.2 Prerequisites and difficulties

The members of staff often discover a fire in a hospital rather quickly as the building is manned around the clock. The fire service and the hospital usually co-operate in fire safety issues, including firemen’s training at the actual site. The large, complex building geometry could cause orientation difficulties and increase evacuation time. There are two main risks associated with a hospital fire. First, problems may arise in the evacuation of unable to move on their own. Second, it is possible that the fire will spread in large hospital buildings due to leakage.

Former Swedish building regulations gave detailed instructions on fire safety. These regulations are principally aimed at smaller, less complex buildings and could therefore be difficult to apply to hospitals. During the survey and analysis carried out by the National

Board of Health and Welfare it was found that fire and evacuation problems have not been solved, despite the use of existing building regulations. Today's performance-based regulations should not result in this problem in future renovations and new buildings.

Hospitals require good communication within and between buildings. These requirements are not always in accordance with the demands of fire safety. Complexity increases with extensions, atriums etc., which could lead to reduced accessibility for the fire service. An unfavourable design of buildings with large open areas and inadequate separation is sometimes handled by compensation solutions like sprinkler installation. Using installations, which are dependent on utilities, is not good, as hospitals should be able to maintain their function in wartime as well as in peacetime. Such solutions can be avoided by careful and competent planning early in the design process.

In case of fire, the spread of smoke is a particular problem. The speed and degree of spread depends on a number of factors, e.g. building geometry, HVAC system, lifts, staircases and shafts. A hospital has a need for easy communications, both vertically and horizontally. These needs are sometimes in conflict with the safety demands on sectioning and integrity.

4.3 Previous fires at hospitals

Hallberg (1992) has presented a summary on the status of knowledge on building evacuation, including fires at hospitals. This summary will be presented here in order to elucidate what could start a fire at a hospital and to analyse how the members of staff responded to the emergency situation.

4.3.1 The Achern fire

A fire started in the basement of an eight floor high hospital building in Achern (Germany). Fire fighters arrived quickly to the scene. However, after a while smoke began to spread to the adjacent stairwell. Due to a small opening in a shaft, the fire then spread from its origin. There was heavy smoke production from the fire, which inhibited movement via the stairwells. The fire quickly affected floors one to three.

Evacuation had to take place via ladders from the outside, as smoke prevented escape via the inside escape routes. 100 patients were evacuated down the ladders. Among the casualties were those whose lives were dependent on medical technology, which failed because of the fire. Insufficient integration and insulation of fire compartments were the main causes of the consequences of the fire.

4.3.2 The Vestal fire

The hospital in Vestal (U.S.A.) is built in the form of a T, with hospital wards in the three wings. A fire occurred in one of the nursing rooms where the door to the corridor was left half-open. The HAVC system transported the smoke away from the smoke detector, which led to increased detection time, also influencing the total escape time. The hospital building was not equipped with sprinklers.

Thanks to closed doors between the corridor and other nursing rooms the fire resulted in only a low number of fatalities. The delay in detection did not have serious consequences as the members of staff responded correctly to the emergency situation.

4.3.3 The Erlangen fire

At the psychiatric clinic in Erlangen (Germany), one of the patients set light to some waste paper in a garbage room. Artificial material on the floor and walls produced heavy black smoke, which spread via the ventilation system to the nursing rooms. The windows in the nursing rooms were locked, to prevent patients from leaving the premises.

The consequences of the fire could have been less serious if the members of staff had used the fire extinguishers available. The rapid flame spread and heavy smoke production could have been prevented by covering the floor and the walls with non-combustible material.

4.3.4 The Dardanelle fire

The cause of fire at the nursing home in Dardanelle (U.S.A.) is unknown. The fire, which started in a linen storage room, spread via a space above the inner ceiling to adjacent corridors and nursing rooms. The door to the fire room was open when the fire started and it was never closed.

The loss of life and property was mainly due to the absence of a fire suppression system, the spread of flames and smoke via spaces and the lack of integrity in the fire separating construction.

4.3.5 The Huddinge fire

In 1991 there was a fire at the Swedish hospital in Huddinge, from which a number of interesting conclusions could be drawn. The fire started on one of the hospital wards when a patient set light to some clothes. The ward was situated on the ground level. There was heavy smoke production and due to a few mistakes there was extensive and unnecessary smoke spread in the building.

After the members of staff discovered the fire the door that separated the ward into two fire compartments was closed. This door was later opened by the fire fighters, which led to smoke spreading into the escape stairwell. The door from the second escape route was left open which led to smoke spread in the entire main stairwell. Locked doors also blocked some escape routes. What should have been an easy task for the fire fighters turned out to be a complex situation, which could have resulted in a number of fatalities due to incorrect human actions.

4.3.6 Summary

Previous experience shows that the option of evacuating patients through windows may be important in saving lives. But this option is not satisfactory. Patients should preferably be evacuated to the protected lobby or via the stairwell. In some of the above described fires, the fire fighters were forced to use outside ladders to ensure the evacuation. Locked exits at psychiatric clinics constitute a problem, which requires special attention. Failure in integrity and insulation often causes flame and smoke spread.

Despite technical measures, it is common that incorrect human actions lead to fatalities and damage to property. Staff training in emergency response is of vital importance.

4.4 Statistics and probabilities

The Swedish Rescue Services Agency is responsible for collecting statistics from fires reported by the local fire services on a regular basis. These statistics show that the most common cause of fire in hospitals is arson. Technical malfunction of apparatus and smoking are other common fire sources in hospitals. Stairwells, nursing rooms and kitchens are the most common locations in which fires start. In 1996 and 1997, the number of fires at hospitals in Sweden was approximately 150 per year. The statistics also showed that about one in four fires did not develop flames. Figure 4.1 illustrates causes of fire in hospitals in Sweden, during 1996 and 1997.

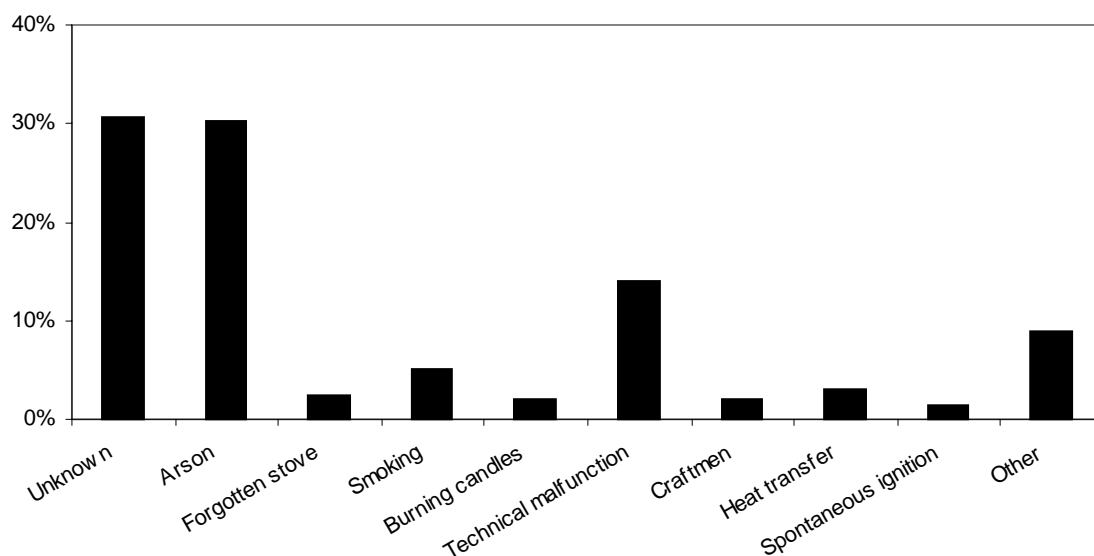

Figure 4.1 Causes of fire in hospitals in Sweden, during 1996 and 1997 (SRV, 1998).

Surveys on how aware the members of staff at two Swedish hospitals were of fire safety and emergency response, have been presented by students in Fire Protection Engineering at Lund University, Sweden (Ericsson et al., 1988 and Bergfeldt et al., 1989). In these surveys it was found that one out of five did not know how to respond to an emergency situation involving a fire. One in ten does not know how to activate the manual fire alarm. Most interesting is that around 60 percent did not believe that they were sufficiently well trained to handle a fire and the related evacuation.

It is most common that fires at hospitals are either self-extinguished or suppressed by members of staff. Only one in ten fires will continue to grow possibly leading to critical conditions.

5 Swedish Building Regulations

The Swedish Board of Housing, Building and Planning is responsible for the built environment and the management of natural resources, physical planning, building and housing. The board is responsible for public requirements on buildings. These primarily concern health, safety, accessibility and energy management. Section 5 in the Swedish Building Regulations (BBR 99) deals with “Safety in Case of Fire”. The regulations consist of mandatory provisions and general recommendations. Text recited from the regulations is written in *italic* and the figures between brackets refer to the relevant section in the regulations.

5.1 General regulations

5.1.1 General (5:1)

Since the regulations of 1994, are performance based, it is always possible for the fire engineer to design the building in other ways than those mentioned in the regulations. Naturally, an extensive analysis is needed to ensure that the safety level is sufficiently high.

Alternative design (5:11)

Fire protection may be designed in a way different from that specified in this section (Section 5) if it is shown by special investigation that the total fire protection of the building will not be inferior to that which would be obtained if all the requirements specified in the section had been complied with.

Documentation (5:12)

Fire protection documentation shall be drawn up. This shall set out the conditions on which fire protection is to be based and the design of the fire protection.

Design by calculations (5:13)

If design of fire protection is based on calculations, calculations shall be based on a carefully selected design fire and shall be performed in accordance with a model, which gives a satisfactory description of the problem at hand. The calculation model selected shall be stated.

Control of design for escape (5:14)

In buildings where there is a high risk of injury to persons, design for escape by calculation may be used only if the correctness of the calculation can be demonstrated by design control.

Sometimes it is necessary to design a building with demands higher than those specified in the regulations. Higher demands on building safety could be required if the fire service is unable to launch an attack within normal time limits. A survey performed at the fire services in the cities of Gävle, Ljusdal and Enköping, Sweden, shows that the emergency force is not able to intervene within the first fifteen to twenty minutes (Sirenen, 1998). When studying fire scenarios at a hospital, this time could be considered too long and may therefore motivate higher demands on safety than those given in the regulations.

5.1.2 Fire resistance classes and other conditions (5:2)

A building shall be constructed to Class Br1, Br2 or Br3. Classification shall take account of factors, which affect the possibility of escape and the risk of injury to persons in the event that the building collapses. The possibility of escape shall be assessed with regard to the height and volume of the building and the activities carried out in the building, and to the number of persons who are expected to be in the building at the same time, and the likelihood that these persons can reach safety on their own.

A building in which a fire would entail a high risk of injury to persons shall be constructed to Class Br1. In such buildings the most stringent requirements are imposed on e.g. finishes and on load bearing and separating structures. A building in which a fire may entail a moderate risk of injury to persons shall be constructed to Class Br2. Other buildings may be constructed to Class Br3.

Buildings, general recommendation (5:21)

Buildings of three or more storeys should be constructed to Class Br1.

Depending on their function, structural elements are assigned to the following classes:

- R (load bearing capacity),
- E (integrity), and
- I (insulation).

Digits specifying the time requirement, 15, 30, 45, 60, 90, 120, 180, 240 or 360 minutes follow the designations R, RE, E, EI and REI.

The following class designations are also used:

- Non-combustible and combustible material and material of low ignitability (combustible material which complies with certain requirements)
- Ignition retardant cladding
- Surface finish of Class I, II or III (of which Class I complies with the most stringent requirements)

5.1.3 Escape in the event of fire (5:3)

General (5:31)

Buildings shall be designed so that satisfactory escape can be effected in the event of fire. Special attention shall be paid to the risk that persons may be injured by the fall of elements of structure or due to falls and congestion and to the risk that persons may be trapped in recesses or dead ends.

Buildings in which people are present not just temporarily should be designed with at least two independent escape routes. If the building consists of more than one storey, there should be at least one escape route from each floor. The distance of travel inside a fire compartment to the nearest escape route shall not be so great that the compartment cannot be evacuated before critical conditions arise. Along an escape route, the travel distance to the nearest stairway leading to another storey, or to an exit leading into the street or similar space, shall not be so great that escape cannot take place rapidly.

In design with respect to the safety of escape, the conditions in the building shall not become such that the limiting values for critical conditions are exceeded during the time needed for escape.

Design conditions, general recommendations (5:36)

In evaluating critical conditions, consideration should be given to visibility, thermal radiation, temperature, noxious gases and the combination of temperature and noxious gases. The following limiting values can normally be applied:

Visibility: level of fire gases not lower than $1.6+(0.1xH)$ m, where H is the height of the room.

Thermal: a short-term radiation intensity of maximum 10 kW/m^2 , radiation: a maximum radiant energy of 60 kJ/m^2 in addition to the energy from a radiation of 1 kW/m^2 .

Temperature: air temperature not higher than 80°C .

5.1.4 Protection against the spread of fire inside a fire compartment (5:5)

Surface finishes and claddings in escape routes shall be of materials that provide negligible contribution to the spread of fire.

In buildings of *Class Br1* or *Br2*, ceilings and internal walls in escape routes shall have surface finish of Class I. The surface finish shall be applied to non-combustible material or to ignition-retardant cladding. In buildings of *Class Br1* the floor covering in escape routes shall be constructed of a material with a moderate propensity to spread fire and evolve fire gases.

5.1.5 Protection against the spread of fire and fire gases between fire compartments (5:6)

Buildings shall be divided into fire compartments separated by structural elements, which impede the spread of fire and fire gases. Each fire compartment shall comprise a room - or associated groups of rooms - in which the activity has no immediate connection with other activities in the building. A fire compartment shall not - with the exception of dwellings, stairways, lift wells and open garages - comprise spaces on more than two storeys unless an automatic water sprinkler installation or other arrangements protect the spaces.

Each fire compartment shall be separated from other spaces in the building by structural elements (including service penetrations, necessary supports, connections and similar structures) constructed to not less than the fire resistance class commensurate with the requirements in the regulations.

Elements of structure shall be constructed to not less than the fire resistance class set out in Table 5.1 below. The fire resistance class in Column 1 ($f \leq 200$) may be applied to dwellings and offices, schools, hotels, garages for cars, shops for the sale of food, residents' store rooms and comparable fire compartments. This class may also be applied to fire load intensities higher than 200 MJ/m^2 for buildings protected by automatic water sprinkler installation.

Table 5.1 Fire resistance classes for different structural elements.

Element of structure	Fire resistance class for a fire load intensity, f (MJ/m ²)		
	f ≤ 200	f ≤ 400	f > 400
Elements of structure separating fire compartments in general, and a floor above a basement	EI 60	EI 120	EI 240

Doors, shutters and access panels in elements of structure separating compartments shall normally be constructed to the same fire resistance class as that which applies for the element of structure in question.

5.1.6 Load-bearing capacity in the event of fire (5:8)

Load-bearing structures shall be designed and sized so that in the event of fire there is adequate structural safety with respect to material failure and instability in the form of local, overall and lateral torsional buckling and similar effects. Parts of the load-bearing structure, including supports, joints, connections and similar structures, shall be designed so that collapse does not occur - during a specified period of time in accordance with the fire resistance classes for elements of structure.

Since the collapse of load-bearing structures is most unlikely to occur within the time frame relevant for escape, the issue is not further discussed.

5.2 Hospital-specific regulations

As a complement to the general regulations there are regulations that are specific for certain places and activities such as assembly halls and nursing institutions.

Nursing institutions (5:242)

Nursing institutions are defined as premises for health and social care and for the care of disabled persons. Examples of nursing institutions are hospitals, nursing homes and residences for senior citizens.

In order to ensure safe evacuation the following equipment should be installed in hospitals:

- Guidance signs to facilitate evacuation.
- Emergency lighting
- Automatic fire alarm. The system shall alert a staffed position.

Fire compartments in nursing institutions should have access to at least two mutually independent escape routes. It is acceptable for these routes to lead through an adjacent fire compartment. Walls, ceilings and floors should be designed so they do not contribute significantly to a fire within the enclosure. Surface materials must comply with the demands for Class Br1 buildings (Section 5.1.4).

Hospital corridors should be separated from adjacent nursing rooms. The integrity of the separation should be at least thirty minutes. Every hospital ward should be designed as a separate fire compartment.

6 Qualitative Design Review

As described in Chapter 3, the fire safety design process begins with a qualitative design review where all input to the risk analyses is given, design criteria established, building and occupants characterised, etc.

6.1 Review of architectural design

Hospitals require good communication within and between buildings. The building should provide hospital wards for patients who need special attention. Nevertheless, the hospital ward is not intended for intensive care. The geometry of the building is designed so that patient transport is possible in beds. The need for horizontal transportation is great. The building should be constructed to Class Br1, according to the Swedish regulations (BBR, 1998).

6.2 Building, environment and occupant characterisation

6.2.1 Building characterisation

The building considered in this work consists of three storeys and a basement. On the entrance floor there is a daytime medical reception, a pharmacy, waiting hall and a cafeteria. The first and second floors consist of two hospital wards each. Figure 6.1 shows a schematic sketch over a two-ward floor. A more detailed view of the hospital building is given in Appendix A.

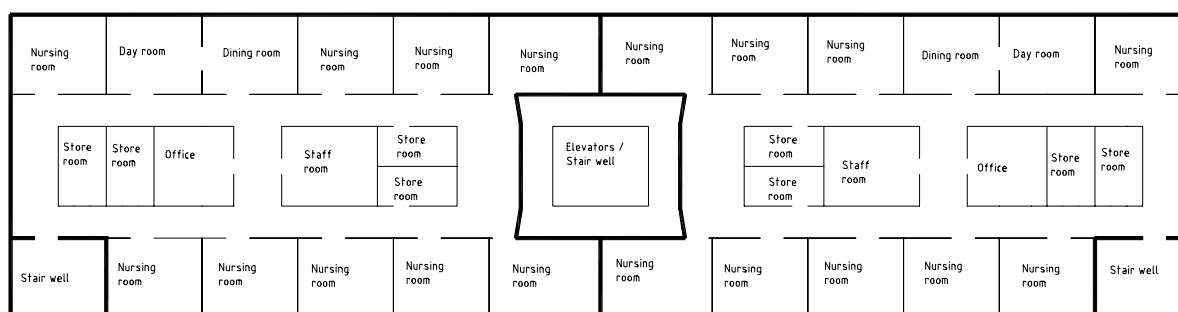

Figure 6.1 Schematic sketch over two-ward hospital floor. Thicker lines illustrate fire compartments.

Each ward consists of nine nursing rooms with four patients in each. There are also a day room, dining room, office, storerooms and a staff room included. The room dimensions are all the same, $5 \times 6 \times 3.2 \text{ m}^3$. The corridor is $32 \times 3 \times 3 \text{ m}^3$. All patient rooms are equipped with two windows, which are located 1.2 m above the floor. The door between the corridor and the room measures $1.5 \times 2.1 \text{ m}^2$.

The floor is divided into three fire compartments (heavy lines in figure 6.1). The two wards are separate fire compartments as well as the protected lobby. All doors between patient rooms and the corridor are assumed to be closed. The door between the protected lobby where the elevators and stairwell are situated is normally closed (self-closing device). According to

the regulations (BBR, 1998) walls between fire compartments are separated with class EI-60 and doors with class EI-30. Patient rooms are not separate fire compartments, but it is assumed that no smoke can leak directly from one room to another.

It is possible to evacuate patients from the hospital ward via a stairwell located at the end of the corridor. This stairwell is of course its own fire compartment. All stairwells have natural smoke ventilation devices installed in the ceiling. All surface finishes and claddings are of materials that provide negligible contribution to the spread of fire. The ceiling and walls are covered with gypsum plasterboard and the floor is concrete.

The HVAC system is designed in accordance with the building's fire compartments. The building is located from a safe distance away from adjacent buildings. The fire service has access to the building from all directions. The normal response time for fire service intervention is estimated to be fifteen minutes after the alarm.

All active and passive fire protection installations will be discussed later in Section 6.7.

6.2.2 Environmental influences

The hospital is located in Sweden, where there is an average temperature of $-2\text{ }^{\circ}\text{C}$ in winter and $15\text{ }^{\circ}\text{C}$ in summer. The wind conditions are assumed to be normal, i.e. an average wind speed of 4 m/s. In winter there will be snow for approximately three months. The climate conditions may affect the performance of smoke and heat ventilation systems. As a hospital requires a well-ventilated environment, the inside air has a temperature of $23\text{ }^{\circ}\text{C}$. The HVAC system provides five total air exchange per hour. The air movement within the building is designed so that smoke spread is minimised.

6.2.3 Occupant characterisation

Staff

The number of staff depends on the time of day. During the daytime there are seven nurses available on each ward and at night, there are only three. The staff is trained in fire safety. The training includes evacuation tactics and the use of portable fire extinguishers. If a fire occurs the staff will most likely be able to put it out. As the alarm system is well maintained the staff relies upon it and is alert to any alarm.

Patients

On each ward there is a maximum of 36 patients. All patients need assistance to evacuate. They are able to walk when supported by staff. Patients are assumed to be sleeping at night and to be awake during the day. The patients are not familiar with the building.

6.2.4 Fire safety management

On each ward there is one person who is designated to deal with fire safety issues. A central hospital organisation for safety and security also exists. The local fire service performs regular fire safety inspections and maintains a dialogue with the hospital staff.

6.3 Fire safety objectives

The main objectives of the fire safety design is to:

- Limit the probability of outbreak of fire
- Ensure safe evacuation of occupants
- Prevent large property losses
- Protect the environment

In this study only the first two objectives have been studied. Organisational fire safety is the key factor in ensuring that a fire does not break out. Regular fire safety inspections and the training of staff are two other key elements in fulfilling the objective. Fire safety design solutions must ensure that the total escape time is shorter than the available safe egress time. A risk-based fire engineering method will be used to analyse this very important objective.

6.4 Evacuation strategy

The main evacuation strategy is to move people from the ward where the fire is located to safe places, e.g. another ward or the protected lobby. Horizontal evacuation is the key tactic. However, if the escape route to the protected lobby is blocked, patients are evacuated via the stairwell located at the end of each corridor, see Figure 6.1.

Evacuation to safe places must be carried out without the assistance of the fire service. If it is necessary, people can continue to perform total evacuation to the outside. The time frame discussed here means that the occupants must, in the worst case, have completed total evacuation approximately thirty minutes after the fire breaks out. The time is dependent on the fire class of the door to the adjacent fire compartment.

6.5 Acceptance criteria

According to the regulations (BBR, 1998), satisfactory escape shall be effected in the event of fire. The following design criteria are established:

- Visibility: Level of fire gases not lower than 1.9 m from the floor
- Thermal: A maximum short-term radiation intensity of 10 kW/m²
- Temperature: Air temperature not higher than 80 °C

If the gases are well mixed, the following criterion will be valid:

- The visibility should not be less than 10 m, i.e. a visibility reduction of 1 dB/m.

These criteria define untenable or critical conditions. In a deterministic study evacuation should be completed before these conditions arise. Probabilistic criteria are those specifying individual risk and the risk of more than 10 and 100 fatalities. Since it is the objective of this study to establish such tolerable risk criteria for hospitals, they can not be given in advance.

The following design equation will be used (Chapter 3):

$$M = t_{\text{critical}} - t_{\text{evacuation}} \quad [3.1]$$

If $M > 0$ then the design solution is satisfactory.

This project does not include any property loss studies and the financial criteria are therefore ignored.

6.6 Identification of fire hazards

The fire hazards in hospitals are identified and described in detail in Chapter 4. The most relevant are:

- Arson
- Technical malfunction
- Forgotten stove, etc.

Fire by arson may occur in storerooms, nursing rooms, stairwells etc. Technical malfunction includes fire in medical devices, televisions, etc. Kitchen devices such as a hot plate on a forgotten stove, coffee machine, etc. may also result in a fire. Malfunctioning fluorescent tubes are also a common source of ignition.

6.7 Fire safety designs

As described in the objectives of this study, three alternative fire safety designs were used to find tolerable criteria for the risk to occupants in a hospital. The three fire safety designs will be described here. More general information was given Section 6.2.

6.7.1 Fire safety design 1 (standard protection)

The first fire safety design solution (FSD1) is a design based on the standard method for hospitals, given by following the general recommendations in the building regulations. FSD1 is the so-called normal protection design. FSD1 consists of:

- Smoke detectors placed throughout the ward.
- Alarm bell to notify occupants of fire.

6.7.2 Fire safety design 2 (active protection)

The second fire safety design solution (FSD2) is a design based on active protection by the use of sprinklers, which lowers risk to occupants and property. FSD2 consists of:

- Sprinkler, designed to extinguish the fire
- Smoke detectors placed throughout the ward

The sprinkler system is designed in accordance with existing Swedish regulations (RUS 120:4, 1993). The sprinkler heads activate at a temperature of 68 °C and are of quick-response type with an RTI value of 35 $\sqrt{\text{m s}}$. Each sprinkler covers an area of 20 m², resulting in two sprinkler heads per nursing room.

6.7.3 Fire safety design 3 (alternative active protection)

The third fire safety design solution (FSD3) employs an alternative approach to lower the risk to occupants. FSD3 uses extended passive protection to minimise the consequences of a fire.

The main components in FSD3 are:

- Smoke and fire separating doors in the corridors
- Smoke detectors placed throughout the ward
- An alarm system that also notifies staff on adjacent wards so that they can assist in evacuation

The smoke- and fire-separating doors are controlled by the alarm system. They will close automatically when a fire is detected on the ward. The separating doors are of class EI-30. In the case of a fire on a ward, the alarm system will also notify adjacent wards of the situation. The staff on these wards will then assist in the evacuation of patients from the ward on which the fire has been detected. The number of staff available to evacuate patients will then be 14 and 6 for daytime and night-time conditions, respectively.

6.8 Fire scenarios for analysis

Based on data from previous hospital fires, most fires start on the wards (Section 4.3). The following fire scenarios were analysed:

- Arson in a nursing room. A wastebasket, cloths, curtains, etc. could be set on fire
- Ignition in medical equipment in a nursing room
- Ignition caused by malfunctioning fluorescent tubes in a storeroom
- Fire in a coffee machine or the electric stove in the staff room
- Fire in the television set in the day room
- Unauthorised smoking in nursing rooms
- Fire in the cafeteria kitchen
- Arson in stairwells, basement, garbage rooms etc
- Electrical failure, causing a fire in a shaft

Naturally, there are additional scenarios to those listed above. The following scenarios will be analysed in detail using expert judgement in the next step – the quantitative analysis:

- The nursing room fire caused by smoking in bed
- The staff room fire caused by electrical failure in a coffee machine
- The cafeteria fire caused by fire in the deep-frying pan

The fire scenarios will be discussed in more detail in the Sections 6.8.1-6.8.3.

6.8.1 Nursing room fire

It is assumed that a patient who is smoking in bed falls asleep and initiates the fire. The hospital bed reaches its maximum RHR of 700 kW after approximately 6.5 minutes. When the bed is completely enveloped in fire the upper gas layer has reached a temperature such that the three other beds in the room ignite, causing the fire to grow to 2 MW after 10 minutes. The initial fire growth rate is 0.005 kW/s². The windows are assumed to break (15

%) when the room temperature reaches 250 °C. A more detailed description of the fire is given in Appendix C.

6.8.2 Staff room fire

Electrical failure in the coffee machine causes the machine to burn. The fire propagates to some plastic receptacles and further on to the curtains. The fire grows rather rapidly and the growth rate is assumed to be 0.015 kW/s². No other objects in the staff room are assumed to be ignited. The staff has the option of closing the door if the fire is detected at an early stage. The maximum RHR for the staff room fire is 800 kW at 4 minutes. The windows are assumed to break (15 %) when the room temperature reaches 250 °C. A more detailed description of the fire is given in Appendix C.

6.8.3 Cafeteria fire

The kitchen in the cafeteria on the entrance floor is equipped with a deep-frying pan. Due to a malfunction of the thermostat the oil is overheated and ignites. The fire spreads to cupboards and other objects in the surroundings. The fire grows very rapidly and after 5 minutes the maximum RHR of 2 MW is reached. The fire growth rate is as high as 0.093 kW/s². The windows are assumed to break (15 %) when the room temperature reaches 250 °C. A more detailed description of the fire is given in Appendix C.

6.9 Method of analysis

The analysis was performed as described in Chapter 2 and Chapter 3. A so-called event tree technique was used to perform the quantitative analysis. Event trees were drawn for each of the three fire safety design solutions. Each design solution was evaluated by using the three design fires given in Section 6.8. The probability and the consequences for each sub-scenario were calculated. The risk is presented as a risk profile.

Computer-based models were used to calculate the time taken to reach untenable conditions, i.e. the safe egress time. A simple hand-calculation model was derived to assess the escape time. When using the event tree technique the sensitivity of different parameters is automatically examined.

7 Quantitative Analysis

In this chapter the event trees will be defined, the fire hazard calculated and the evacuation process estimated.

7.1 Event trees

The event tree consists of a number of events (questions) where two answers are possible, “Yes” or “No”. The questions are put so that the answer “Yes” results in a better outcome, i.e. lessening the consequences. A positive answer thus leads to longer available safe egress time or shorter evacuation time. A large number of sub-scenarios are derived from the event trees. All event trees are given in detail in Appendix B.

All event trees have the same initial characteristics stating the time of day, the fire location and whether the fire will continue to grow. The first occurring event is naturally a fire starting in the building. The following initial events are:

- Daytime fire? → Fire location? → Non-flaming fire? → Fire suppressed by staff?

7.2 Events

Depending on the fire safety design and fire location, all or some of the events listed in this chapter make up the event trees.

7.2.1 Initial fire

The first event occurring is the initial fire. The likelihood of a fire at a hospital can be found in various sources of statistics. In two fire design handbooks (BSI, 1997 and FEG, 1996) the probability of a fire starting at a hospital is 0.3 per year. Rutstein (1979) gives an equation for the probability of a fire given the floor area:

$$P_{\text{fire}} = 0.0007 A^{0.75} \quad [7.1]$$

The entire hospital has an area of approximately 3500 m² that sets P_{fire} to 0.32 when using equation 7.1. This result is completely in line with the value given in the handbooks. For a single hospital ward, table 7.1 outlines fire frequencies for three towns in Sweden.

Table 7.1 Fire frequencies in hospital wards per year in three towns in Sweden (Frantzich, 1996)

Town	Fire frequency per year
Helsingborg	0.038
Lund	0.078
Solna	0.068

The model hospital consists of four wards plus the entrance floor and basement. Statistics (SRV, 1998) show that three out of four fires in hospitals are located in one of the wards, therefore the fire frequency per year for the entire hospital could be calculated, using Table 7.1, to be 0.2-0.4. A frequency of 0.3 fires per year was used as P_{fire} for the entire model hospital.

7.2.2 Daytime fire?

Statistics from the fire departments in the Swedish cities of Helsingborg, Lund and Solna (Frantzich, 1998) show that the probability of a fire occurring during the day is 0.67 and at night, 0.33. During daytime conditions, the number of staff available is 7 persons. Patients are assumed to be awake. During night-time the number of staff is reduced to only 3 persons and patients are assumed to be asleep.

7.2.3 Fire location?

The fire is assumed to be initiated in either of these three locations; the nursing room, the staff room and the cafeteria. The branch probabilities are set to 0.45 for the nursing room fire, 0.30 for the staff room fire and 0.25 for the cafeteria fire. At night the cafeteria fire is very unlikely to occur and is therefore not considered to be a possible fire location during night-time. The probabilities of a nursing room fire and staff room fire during the night are 0.60 and 0.40 respectively.

7.2.4 Non-flaming fire?

Statistics (SRV, 1998) show that the probability of a non-flaming and self-extinguishing fire at hospitals is 0.42. A fire must be initiated and continue to grow if the ward is to be evacuated. A non-flaming fire is assumed not to lead to untenable conditions within the time scale discussed here. If a flaming fire arises, untenable conditions may occur. The probability has been increased somewhat in order to include extinguished fires that are not reported.

7.2.5 Fire suppressed by staff?

The probability of successful fire suppression by staff depends on the time of day. During daytime the probability is 0.78 for the nursing room and cafeteria fires and 0.90 for the staff room fire. At night the probability of successful fire suppression is reduced to 0.65 for the nursing room and cafeteria fires and 0.80 for the staff room fire (SRV, 1998). If the fire is suppressed at an early stage by the staff, untenable conditions will not occur. If the fire is not suppressed, untenable conditions may occur.

7.2.6 Automatic detection?

The availability of the detection system (alarm bell included) is set to 0.80 (BSI, 1997). If the automatic detection system is working, the fire will be detected at an early stage, which reduces the evacuation time. If automatic detection fails, the fire will be detected later by the staff, and the evacuation time increases. Detection times will be discussed later in Section 7.4.1.

7.2.7 Door to room closed?

The probability that the door will be closed after evacuation is assumed to be 0.90 (Frantzich, 1998). If the door to the nursing room is closed it will only be open for a short time while patients are evacuated from the room. This minimises the amount of smoke that spreads to the corridor. If the door to the room on fire is left open after the patients are evacuated, smoke and fire will spread to the adjacent corridor

7.2.8 Staff response correct?

As discussed in Chapter 4, approximately 80 % of the staff is considered to be sufficiently trained in fire related subjects. Correct staff response means that the staff takes appropriate action to alert and evacuate the patients. Naturally, there will always be a number of staff who have not attended fire protection training. Thirty seconds will be added to the evacuation time if staff response is not correct.

7.2.9 All escape routes accessible?

Considering the building characteristics, it is assumed that three out of ten fires at the ward block block one of the escape routes. The probability of all escape routes being available is assumed to be 0.70. All escape routes are accessible if the fire does not block any of them. If the main horizontal escape route is blocked, staff back-up is not available and queuing will occur in the stairwell entrance.

7.2.10 Door closed after fire?

This event is only involved in the staff room fire. The likelihood of the door being closed after fire is estimated to be 0.50. It is only possible for the staff to close the door if the fire is detected by automatic detection. Otherwise the fire will have grown too much, preventing the staff from closing the door. A closed door will limit the consequences of the fire. If the door remains open, fire and smoke will spread quicker reducing the available safe egress time.

7.2.11 Fire separation sufficient?

This event is only valid for the cafeteria fire. It is assumed that the probability of successful fire separation from the cafeteria to the medical care unit is 0.90. If fire separation is sufficient, fire and smoke will not spread to the adjacent medical care unit. If the separation fails, fire and smoke will spread to the medical care unit, resulting in possible critical conditions there.

7.2.12 Sprinkler successful?

The probability of successful sprinkler activation is 0.95 (BSI, 1997). Successful sprinkler activation is rather conservatively considered to only control the fire, preventing the RHR from increasing. It is also assumed that if critical conditions have not occurred before sprinkler activation, they never will. If the sprinkler fails to operate the fire will continue to propagate as if there were no sprinkler installed at all.

7.2.13 Fire and smoke separation successful?

The probability that all three fire and smoke separators operate successfully is 0.62, i.e. 0.85^3 (BSI, 1997). If smoke separation is successful the smoke will only spread to one of the wards two corridors. If the separation is unsuccessful, the movement of smoke will continue unaffected.

7.2.14 Staff back-up available?

The probability of staff back-up being available is assumed to be 0.80. Available staff back-up means that staff from adjacent wards will be able to help in the evacuation process. The total number of staff available is 14 during the day and 6 at night. If staff back-up is unavailable no assistance will be given in evacuation.

7.2.15 Remarks

The number of sub-scenarios is very high. In Appendix B, where the event trees are illustrated, it can be seen that the FSD1, FSD2 and FSD3 contain 52, 94 and 124 sub-scenarios, respectively. A grand total of 270 sub-scenarios are included in the QRA.

7.3 Fire development

The computerised two-zone model CFAST (Peacock et al., 1994) has been used to calculate the time elapsed before critical conditions are reached. (Critical conditions are defined by the building regulations.) The most relevant criterion is that regarding smoke interface height. In the model hospital the critical conditions occur when the interface reaches a height of 1.9 m above the floor.

In order to calculate smoke detector and sprinkler activation times, the computer program Detact-T2 (Evans et al., 1985) has been used. The model calculates the activation time for a given fire and detector configuration. Smoke detectors are assumed to behave like heat detectors with a much shorter response, i.e. with an RTI value of $0.5 \text{ (m s)}^{1/2}$ and an activation temperature of $5 \text{ }^\circ\text{C}$ above the ambient. The sprinklers used in FSD2 have an RTI value of $35 \text{ (m s)}^{1/2}$ and an activation temperature of $68 \text{ }^\circ\text{C}$.

In this Section the fire development will be discussed briefly. For further details please see Appendix B.

7.3.1 The nursing room fire

Within the first minute, a critical interface height will occur in the enclosure in fire. If the door to the nursing room is closed, critical conditions will not occur in the adjacent corridor. But if the door is left open, an untenable interface height will be reached in the corridor after 210-240 s. The smoke detector and the sprinkler will activate after 80 s and 250 s, respectively. The windows are conservatively assumed to break by 15 % when the room temperature reaches approximately $250 \text{ }^\circ\text{C}$.

7.3.2 The staff room fire

In the enclosure of fire a critical interface height occurs within the first minute. If the door is closed after the fire is detected the consequences are lessened dramatically. Critical interface height occurs after 180 to 300 s, depending on the status of the door. The smoke detector and the sprinkler activate after 55 s and 170 s, respectively. The windows are assumed to break by 15 % when the room temperature reaches approximately $250 \text{ }^\circ\text{C}$.

7.3.3 The cafeteria fire

The fire in the cafeteria occurs on the spacious entrance level. If the cafeteria and the medical care unit are successfully separated by the fire compartmentation, there will be no smoke spread to the care unit. A critical interface height is reached after approximately 4 minutes. If fire separation fails, critical conditions will occur in the medical care unit after 6 minutes. The smoke detector and the sprinkler in the cafeteria activate after 60 s and 200 s, respectively. In the medical care unit, smoke detectors activate after 220 s.

7.4 Evacuation

As mentioned before, the evacuation phase consists of three steps that are here assumed to be independent. These are detection, reaction and travel.

7.4.1 Detection time

If the automatic detection system is successful, the detection time is determined by the time for smoke detector activation, as specified above. However, if the automatic detection system fails, one must rely on manual detection by the staff or patients. Table 7.2 gives both the calculated and the assumed detection times.

Table 7.2 Calculated and assumed detection times for the three design fires.

Fire location	Automatic detection	Manual detection
Nursing room fire	80 s	90 s (day) 120 s (night)
Staff room fire	55 s	60 s (day) 90 s (night)
Cafeteria	60 s	60 s (day)

7.4.2 Reaction time

After the fire has been detected, either automatically or manually, the staff spends some time interpreting the situation. As the staff is trained to respond to fire alarms, the reaction time is considered to be very short only 10 s for the nursing and staff room fires. For the cafeteria fire the reaction time is longer, approximately 90 s in the cafeteria and entrance hall and 30 s in the medical care unit.

7.4.3 Travel time

The travel time is calculated by hand using a simple formula. The travel time involves the following steps

- The staff moves to the patient in the nursing room (t_{staffM})
- The staff prepares the patient for transportation (t_{care})
- The staff assists the patient to move to a safe area (t_{patM})
- The staff and patient queue at the exit (t_{queue})

This procedure is repeated until all the patients have been evacuated, or until critical conditions occur in the corridor. The number of repeat journeys is given by the ratio between the number of patient and staff present to assist in evacuation. Using the information above, the travel time can be calculated using Equation 7.2:

$$t_{\text{travel}} = (t_{\text{staffM}} + t_{\text{care}} + t_{\text{patM}} + t_{\text{queue}}) \times (\text{No}_{\text{pat}} / \text{No}_{\text{staff}}) \quad [7.2]$$

When back-up is available the ratios are 3 and 6 for daytime and night-time respectively, and when there is no back-up the ratios are increased by a factor 2.

Queuing only occurs when all of the escape routes are not available. The queuing time depends on the number of people present and is calculated with Equation 7.3 (Jönsson et al., 1994) given below:

$$t_{\text{queue}} = N_o / (W \times f) \quad [7.3]$$

Where N is the number of people present, W is the width of the opening [m] and f is the flow factor $[(m \text{ s})^{-1}]$. The queue time varies between 4 and 19 s.

When calculating the travel time for the people on the entrance level (cafeteria and medical care unit), Equations 7.4 and 7.5 (Jönsson et al., 1994) are used.

$$t_{\text{travel}} = t_{\text{walk}} + t_{\text{queue}} \quad [7.4]$$

$$t_{\text{walk}} = D / v \quad [7.5]$$

D denotes the walking distance [m] to the emergency exit and v is the walking speed [m/s]. The travel times in the nursing wards vary between 2.5 and 12 minutes, depending on the patient to staff ratio. Characteristic travel times for people on the entrance level are less than 1 minute for both the cafeteria and the medical care unit.

7.5 Assessment vs. criteria

The design equation given in Chapter 3 is repeated below:

$$M = t_{\text{critical}} - t_{\text{detection}} - t_{\text{reaction}} - t_{\text{travel}} \quad [3.1]$$

If $M > 0$, the design solution is satisfactory. The greatest advantage when using an event tree approach is that consideration is taken as to whether the fire protection installations are working or not. The safety margin M can therefore not meet the design criteria for all sub-scenarios. The criteria must therefore be probabilistic. The outcome of the design equation has been calculated for each sub-scenario and the risk profiles constructed. Appendix C gives all sub-scenarios and their specific design equation values.

7.5.1 Fire safety design 1 – standard protection

The mean risk is calculated to be 0.27 people exposed to critical conditions per year. The risk profile is illustrated in Figure 7.1.

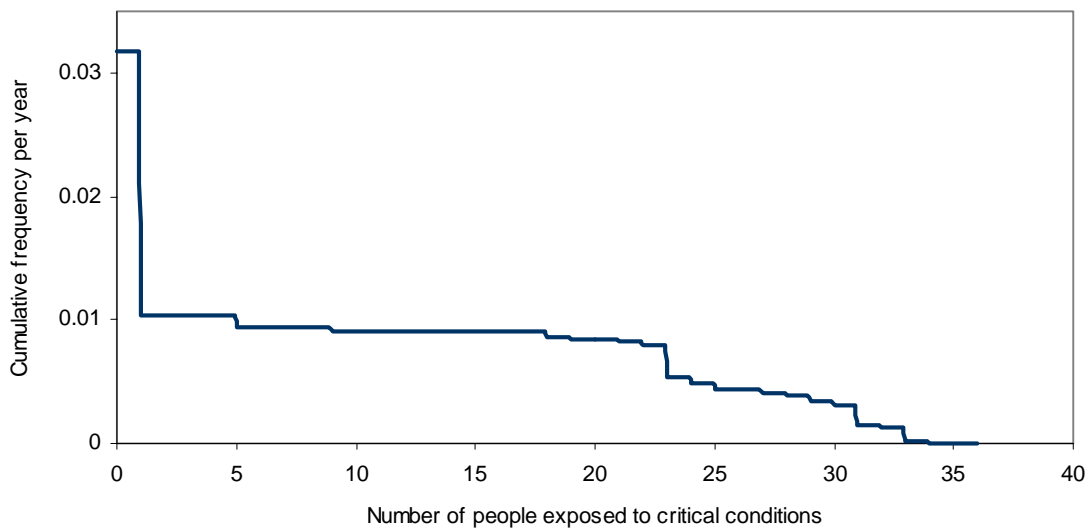

Figure 7.1 Risk profile for FSD1 (standard protection)

7.5.2 Fire safety design 2 – active protection

The mean risk is calculated to be 0.09 people exposed to critical conditions per year. The risk profile is illustrated in Figure 7.2.

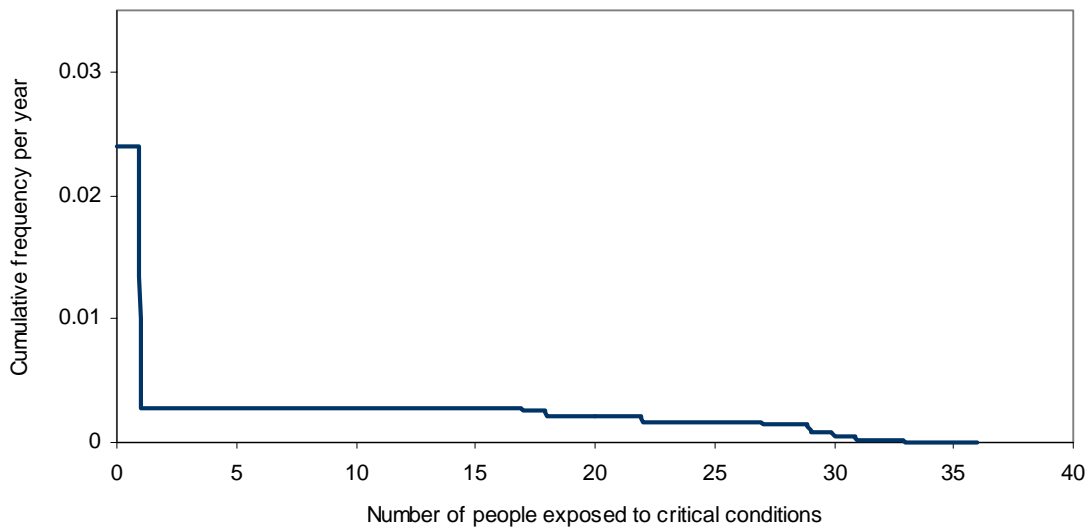

Figure 7.2 Risk profile for FSD2 (active protection)

7.5.3 Fire safety design 3 – alternative active protection

The mean risk is calculated to be 0.18 people exposed to critical conditions per year. The risk profile is illustrated in Figure 7.3.

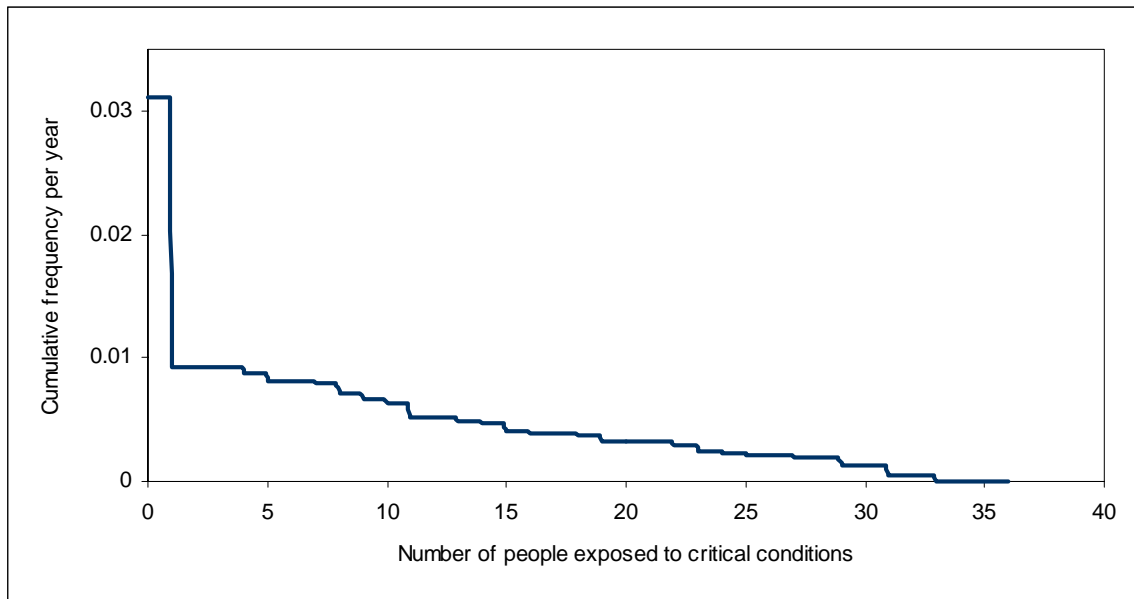

Figure 7.3 Risk profile for FSD3 (alternative active protection)

8 Risk Evaluation

By evaluating the risk it is possible to find those parameters that have the greatest influence on the result. For clarity, the risk profiles for the three fire safety designs are given in Figure 8.1.

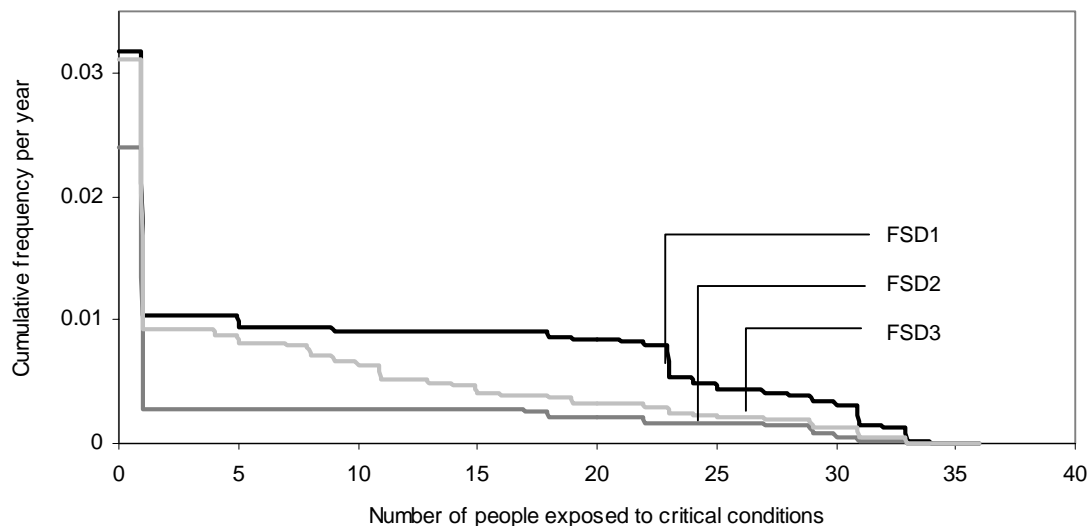

Figure 8.1 Risk profiles for the three fire safety designs. The upper (black) line represents FSD1, the middle (light grey) line is for FSD3 and the lower (dark grey) line is for FSD2.

8.1 Fire safety design 1 – standard protection

The risk profile for FSD1 illustrates that there is a relatively high risk for serious consequences, i.e. more than 20 people exposed to critical conditions. The evacuation of patients is highly dependent on the ratio between the number of patients and staff available to assist in evacuation. In order to examine the sensitivity of the ratio parameter, risk profiles were derived for a number of patient to staff ratios. The ratio during normal conditions is 6 during daytime and 12 during the night. In Figure 8.2, the number of staff has been increased by factors 2 and 3, resulting in lower risk.

The mean risk of being exposed to critical conditions for the normal situation is 0.27. The corresponding values for twice and 3 times the number of staff are 0.18 (-33 %) and 0.11 (-59 %), respectively. There are at least three ways for the hospital management to decrease the patient to staff ratio. First, the number of patients on the ward could be decreased. Second, the number of staff employed could be increased. Third, the number of staff could be increased in the case of an emergency using the back-up alarm system described in FSD3 (chapter 6.7.3).

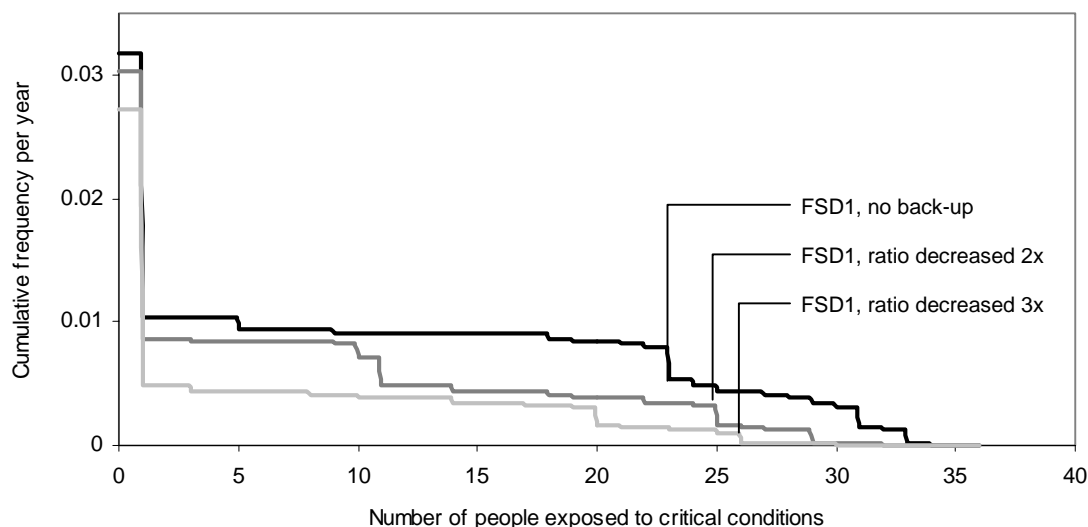

Figure 8.2 A comparison of the risk profiles for normal and improved staff availability. The upper line represents normal conditions, the middle line a patient to staff ratio decreased by a factor 2 and the lower line a ratio decreased by a factor 3.

8.2 Fire safety design 2 – active protection

The installation of sprinklers provides effective protection against untenable smoke and fire spread. The mean risk is lowered by 67 % in FSD2 compared with the standard design. However, even when sprinklers are installed there is a high-consequence low-probability tail which can not be reduced without decreasing the patient to staff ratio

The installation of sprinklers also provides effective protection to property, but is associated with high installation and maintenance costs.

8.3 Fire safety design 3 – alternative active protection

Using smoke-separating doors to limit smoke spread combined with a back-up alarm system lowers the risk by about 33 %. The risk profile has a quite different appearance compared with the others. Between one and ten people exposed to critical conditions the profile corresponds well with the profile for the standard design (FSD1), but for ten or more exposed people the profile agrees with the sprinkler risk profile.

8.4 Conclusions

The most cost efficient way to reduce the risk of people being exposed to critical conditions in the case of fire is to install an alarm system which alerts members of staff on adjacent wards so that they can assist in the evacuation process.

Installing smoke-separating doors in the ward minimises smoke spread and therefore lessens the consequences of a fire. This measure is associated with low costs, but the smoke doors available today do not have a sufficient reliability (Section 7.2.13).

The installation of sprinklers may be regarded as an option where there is a possibility to fight the fire every minute around the clock. This system protects lives and property, but is associated with high costs.

Among the conclusions it is useful to present which parameters that have the highest influence on safety in the case of fire. As the objective of the study was to evaluate how human as well as technical error affects safety, the following points are noted.

- If the members of staff respond correctly by closing the door to the room of fire origin, the fire and its consequences will largely contained inside.
- If the sprinkler system is successful, the building is considered to be safe.
- If smoke barriers are installed in the corridors the consequences are lessened dramatically.

However, if above actions and measures are not taken, the consequences will be serious resulting in a low-probability, high-consequence outcome.

It is clear that the building regulations of today do not provide for sufficient safety for patients in hospitals. The key factor for hospital safety is the patient to staff ratio. If the fire safety engineering method (Chapter 3) had been used, the fire safety level would have been acceptable. However, in cases of human error and the failure of protection installations the risk is obvious. It is my recommendation that the regulations incorporate codes on how to improve the patient to staff ratio in the case of fire.

9 Tolerable Risk Criteria

The establishment of tolerable risk criteria is based on the arguments outlined in Chapter 2. The aim of established risk criteria is to provide guidance for engineers in designing fire protection in buildings, including hospitals. It was stated in section 8.4 that today's regulations do not provide for sufficient safety for patients in hospitals. Therefore, the here proposed risk criteria will be more stringent than the result of the standard design.

9.1 Deriving tolerable criteria

Risk criteria should be expressed in terms of an upper and lower limit for risk tolerance and the elevation of the curve. However, it is here difficult to derive an upper limit. Therefore the tolerable risk criteria will only be established via a lower line for risk tolerance. Having the three risk profiles for FSD1, 2 and 3 derived here in mind, the following specifications can be drawn up:

- Lower limit for risk tolerance $F = 10^{-1}$ for $N = 1$.
- The elevation of the curve is -1 .
- There should be a vertical line for risk tolerance, saying that no more than 50 people should be exposed to critical conditions.

Figure 9.1 shows the tolerable risk criteria compared with the derived risk profiles.

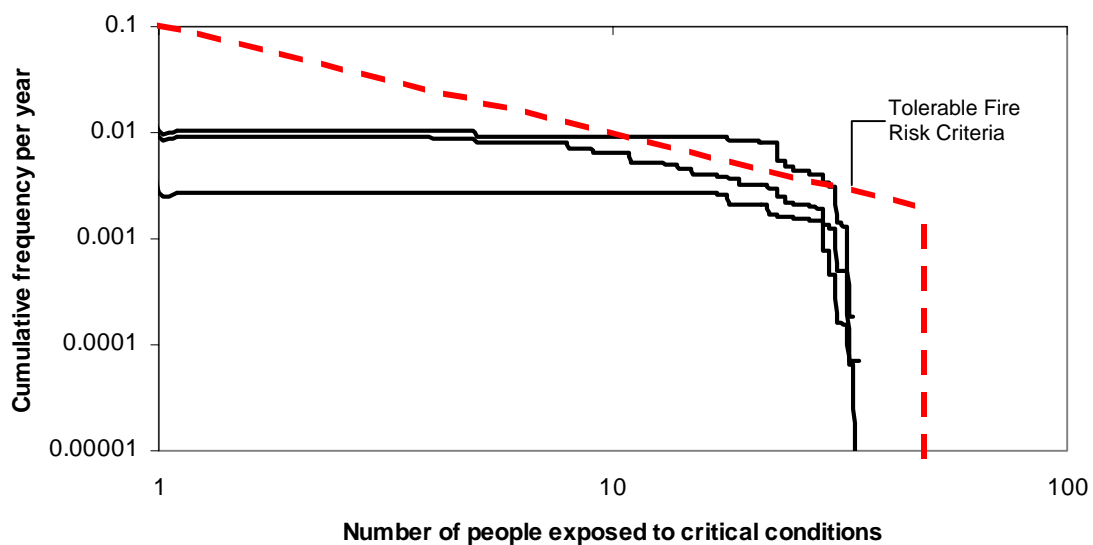

Figure 9.1 The lower limit of the tolerable fire risk criteria for hospitals. If the patient to staff ratio is increased, the part of the FSD1 risk profile which is above the lower limit for risk tolerance will disappear. Note that critical conditions are not the same as lethal conditions.

9.2 Limitations

The calculations are subject to a number of limitations. For example, does the model used to predict time to critical conditions involve a specific model uncertainty. There are also limitations in selecting the design fire. But, by using the event tree approach and three different design fires, the limitations are minimised. Fire specifications and development were chosen conservatively so as to represent a worst credible case. Using this approach will hopefully lead to a fire safety design solution with a safety margin.

The evacuation process is treated rather simply with the same mean staff and patient travel time, transport preparation time, etc. for all sub-scenarios (except for differences in daytime and night-time conditions). The patients are assumed to need some help in evacuation. Frantzich (1996) divides patients into three classes depending on how much help they need (none, little and much). Using the “little help” definition for patient requirements for evacuation produces a reasonable result. If all patients had been assumed to need no help, the consequences would have been unrealistic mild, and if they had been assumed to require much help (bed transport), the consequences would have been unrealistic severe. The established risk criteria are therefor considered to be reasonably good.

When assessing the risk, it would have been more appropriate to use fatalities due to fire instead of exposure to critical conditions. Calculating fatalities in a fire is, however, difficult. People react differently to the same exposure. Critical conditions are however, defined by regulations and evacuation should be carried out before they occur.

9.3 Future use of the results

This is a new approach in the field of tolerable risk. The method must, therefore, be evaluated. It would be useful to compare the results of this study with the ones achieved when deriving tolerable risk criteria for other activities. The results will find use in the future for checking safety levels when designing new or remodelling old hospitals, comparing future established risk criteria for other building types, and in giving politicians an idea on the safety level provided by today’s regulations.

10 References

BBR 99, *Boverkets Byggregler 1999*. BFS 1993:57 med ändringar tom BFS 1998:38, Boverket, Karlskrona, 1998. (In Swedish)

Bergfeldt, M., Frantzich, H., Johansson, I., Thorné, Ö., *Utrymning och mänskliga reaktioner vid länssjukhuset i Ryhov*, , Department of Fire Safety Engineering, Lund university, Lund, 1989. (In Swedish)

Boverket: *Utvärdering av ändringar i byggregleringen: brand*. Rapport 1997:9, Karlskrona, 1997. (In Swedish).

BSI Draft for Development DD240: *Fire safety engineering in buildings. Part 1: Guide to the application of fire engineering principles*. British Standards Institution, London, 1997.

Charters, D., *Quantified Assessment of Hospital Fire Risks*, Proceedings of Interflam '96, 1996.

CPQRA, *Guidelines for Chemical Process Quantitative Risk Analysis*. Center for Chemical Process Safety of American Institute of Chemical Engineers, New York, 1989.

Det Norske Veritas: Davidsson, G., Lindgren, M.m Mett, L. *Värdering av risk (Evaluation of Risk)*. SRV report P21-182/97, Karlstad, 1997. (In Swedish)

Ericsson, M., Höglund, P., Kallum, J., Marberg, P-A., *Utrymning och säkerhet vid Thoraxkliniken, Lunds lasarett*, Department of Fire Safety Engineering, Lund university, Lund, 1988. (In Swedish)

Evans, D.D., Stroup, D.W., *Methods of Calculating the Response Time of Heat and Smoke Detectors Installed below Large Unobstructed Ceilings*. NBSIR 85-3167, National Bureau of Standards, Gaithersburg, 1985.

FEG, *Fire Engineering Guidelines*. Fire Code Reform Centre, Sydney, 1996.

Frantzich, H., *Fire Safety Risk Analysis of a Health Care Facility*. Report 3085, Department of Fire Safety Engineering, Lund university, Lund, 1996.

Frantzich, H., *Uncertainty and Risk Analysis in Fire Safety Engineering*. Report 1016, Department of Fire Safety Engineering, Lund university, Lund, 1998.

Hallberg, G., *Utrymning av vissa offentliga arbetslokaler – sammanställning av kunskapsläget*. Rapport R2:1992, Byggnadsfunktionslära, KTH, Stockholm 1992. (In Swedish)

International Electrotechnical Commission (IEC): *International Standard 60300-3-9, Dependability management – Part 3: Application guide – Section 9: Risk analysis of technological systems*, Geneva, 1995.

Jönsson, R., Frantzich, H., Karlsson, B., Magnusson, S.E., Ondrus, J., Petersson, O., Bengtson, S., Osterling, T., Thor, J., *Brandskydd – Teori och Praktik*. Brandskyddslaget, Stockholm, 1994. (In Swedish)

Jönsson R., Lundin J., “*The Swedish Case Study – different fire safety design methods applied on a high rise building*”, Report 3099, Department of Fire Safety Engineering, Lund university, Lund, 1998.

Peacock, R.D., Jones, W.W., Forney, G.G., Portier, R.W., Reneke, P.A., Bukowski, R.W., Klotke, J.H., *An Update Guide for HAZARD I, Version 1.2*. NISTIR 5410, National Institute of Standards and Technology, Gaithersburg, 1994.

RUS 120:4, *Standard for automatic water-sprinkler-systems*. The Swedish Association of Insurance Companies, Stockholm, 1993.

Rutstein, R., *The estimation of the fire hazard in different occupancies*. Fire Surveyor, Vol 8, No. 2, pp 21-25, 1979.

Socialstyrelsen: *Akutsjukhus – funktionssäkerhet i fred och krig*, SoS-rapport 1996:1, Stockholm , 1996. (In Swedish)

SRV: Swedish Rescue Service Agency, personal communication with Mr. Johan Munthe, Riskenheten, Räddningsverket, Karlstad 1998. (In Swedish)

Sirenen, *Offical Journal*, Swedish Rescue Services Agency, No 5, Karlstad, 1998. (In Swedish)

A Drawings

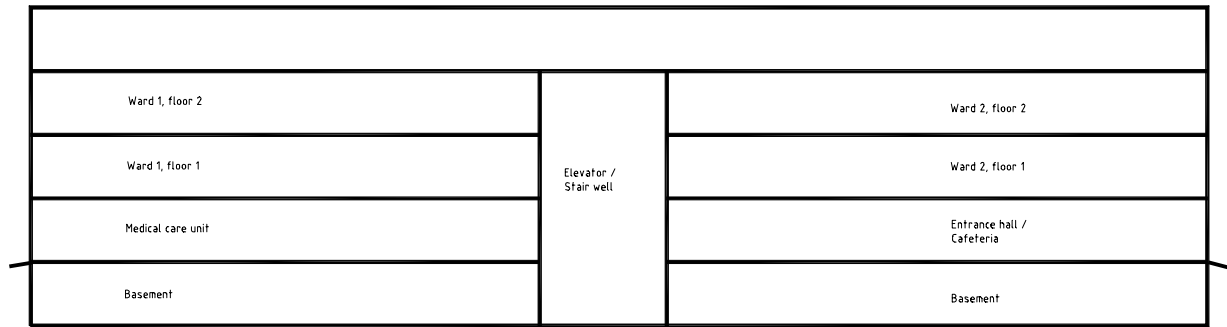

Figure A.1 Section view of the hospital building. Thick lines illustrate fire compartments.

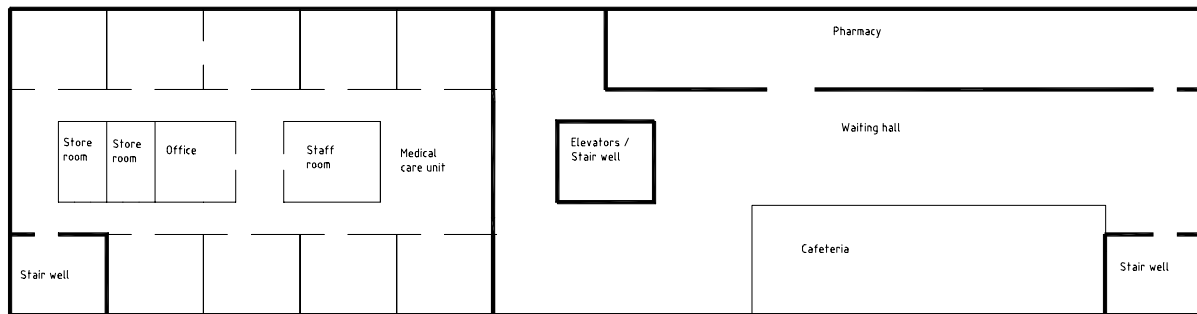

Figure A.2 Plan view of the entrance floor where the cafeteria and the medical unit are located. Thicker lines illustrate fire compartments.

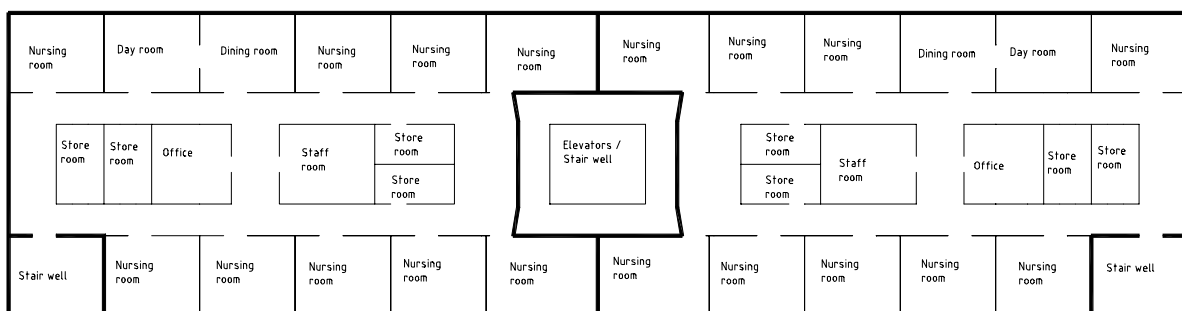

Figure A.3 Plan view of the two-ward hospital floor. Thicker lines illustrate fire compartments.

B Event trees for FSD1, FSD2 and FSD3

This appendix contains the complete event trees used in the quantitative analysis. For each sub-scenario, the time to reach critical conditions is calculated as well as the evacuation process. The consequence and probability is given for each sub-scenario.

Specification for the event trees

- The event tree for FSD1 (standard protection) includes 52 sub-scenarios and has a mean risk of 0.27 people being exposed to critical conditions per year.
- The event tree for FSD2 (active protection) has mean risk of 0.09 people being exposed to critical conditions per year. The event tree contains 94 sub-scenarios.
- The event tree for FSD3 (alternative active protection) includes 124 sub-scenarios and has a mean risk of 0.18 people being exposed to critical conditions per year.

Please note that the probabilities for each sub-scenario must be multiplied by the value of P_{fire} (0.3) to obtain an accurate risk (Chapter 7). N.A. in the column for t_{critical} , denotes not applicable, i.e. that critical conditions will not occur.

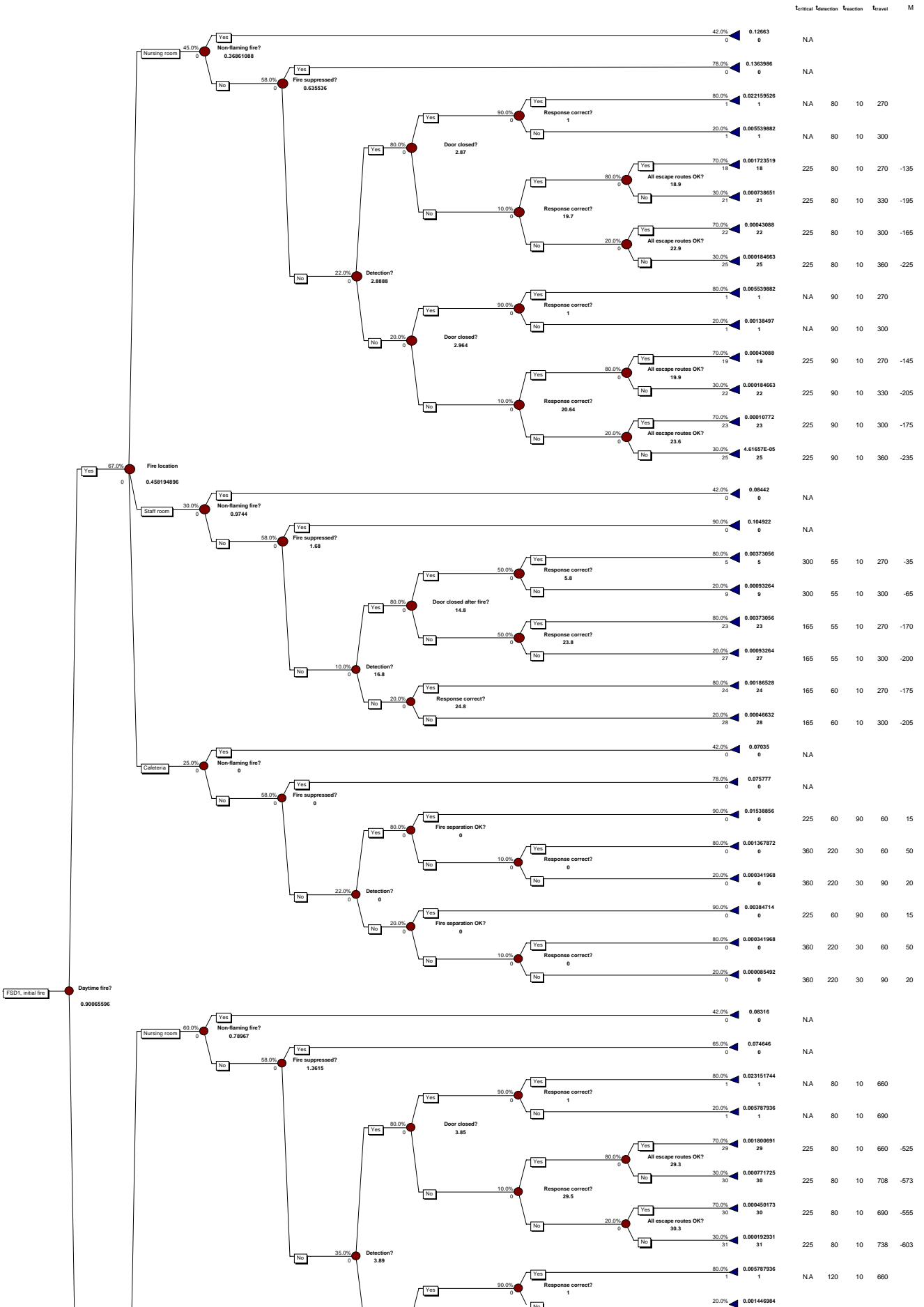

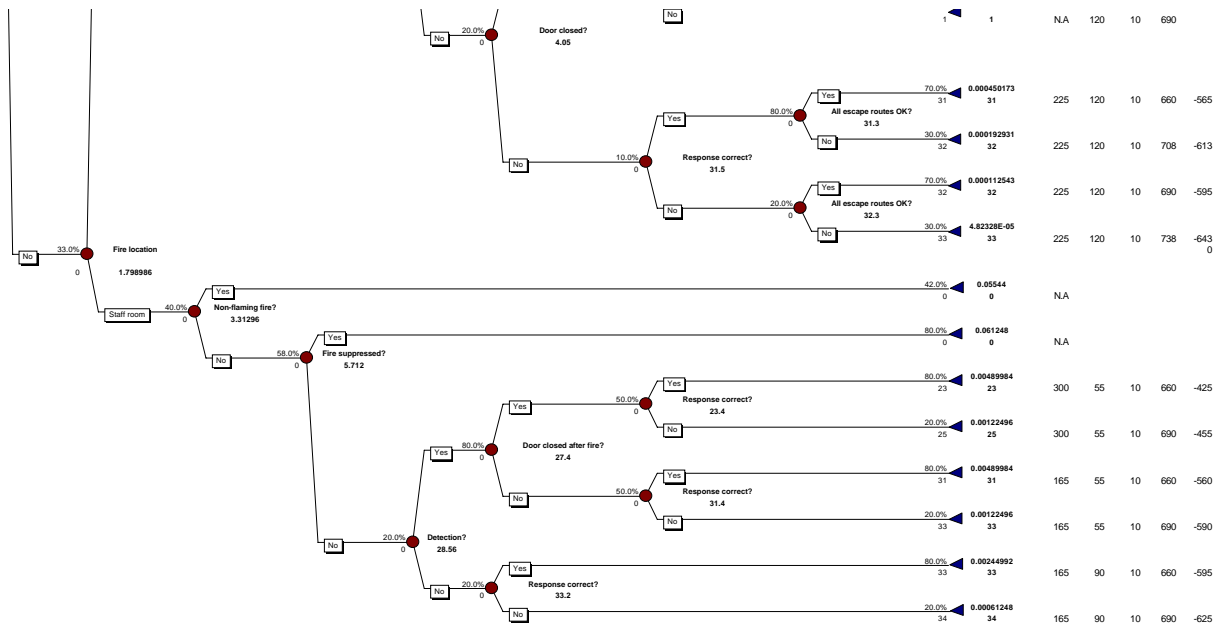

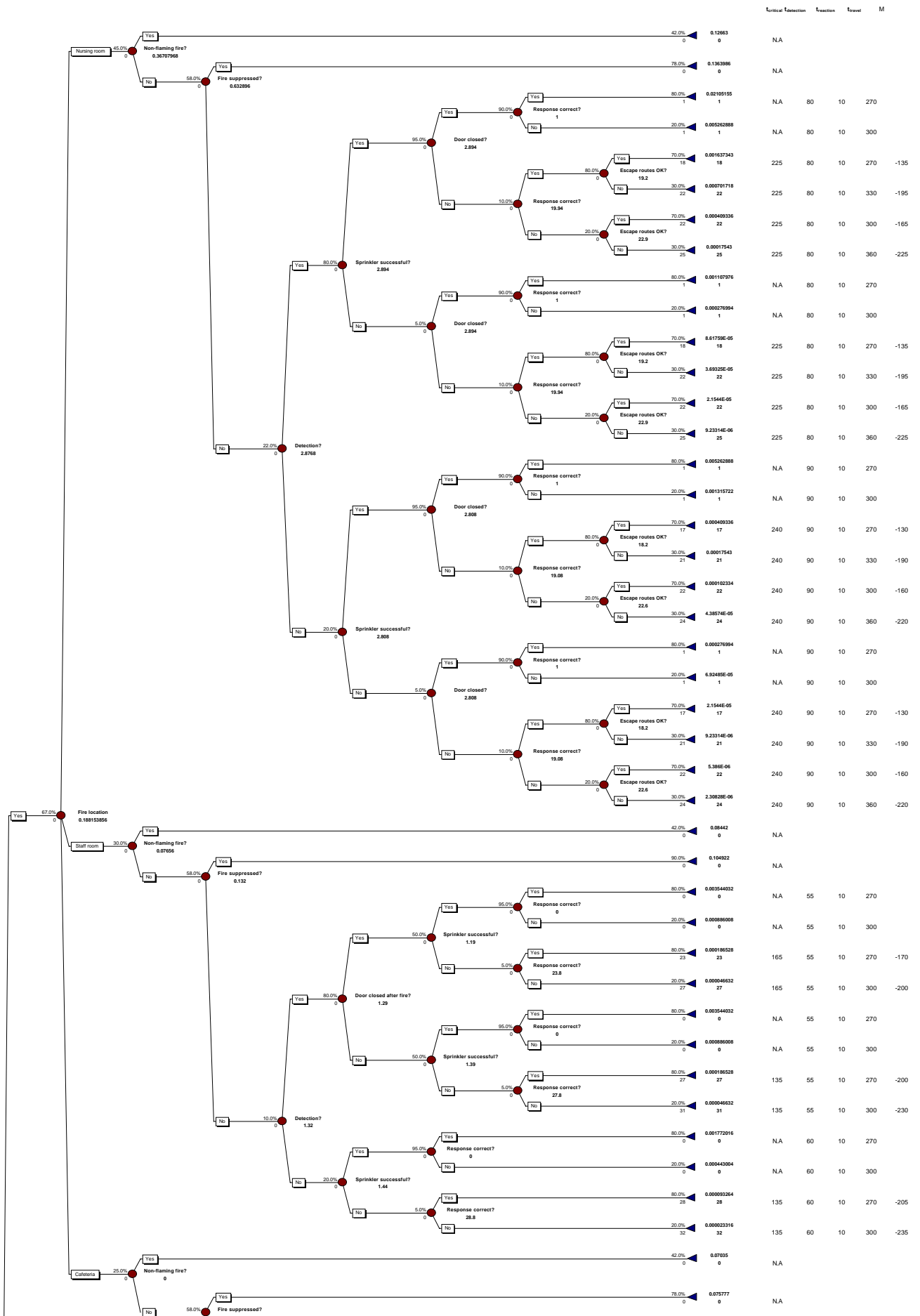

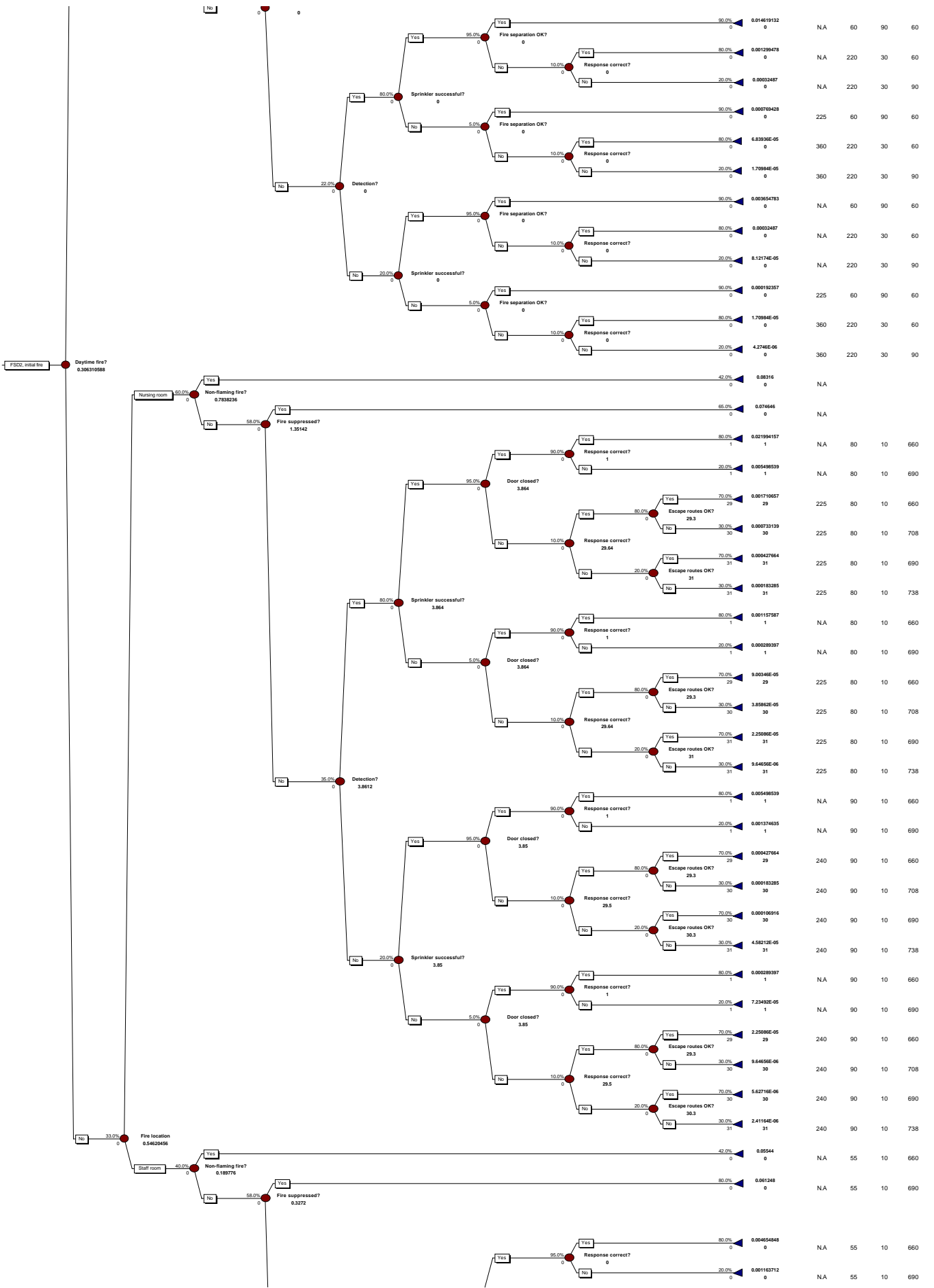

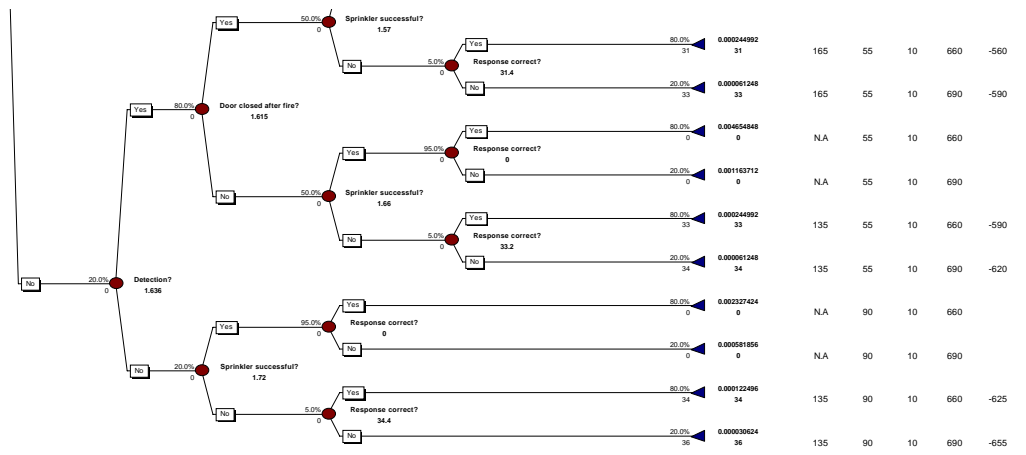

Location Location Location Location M

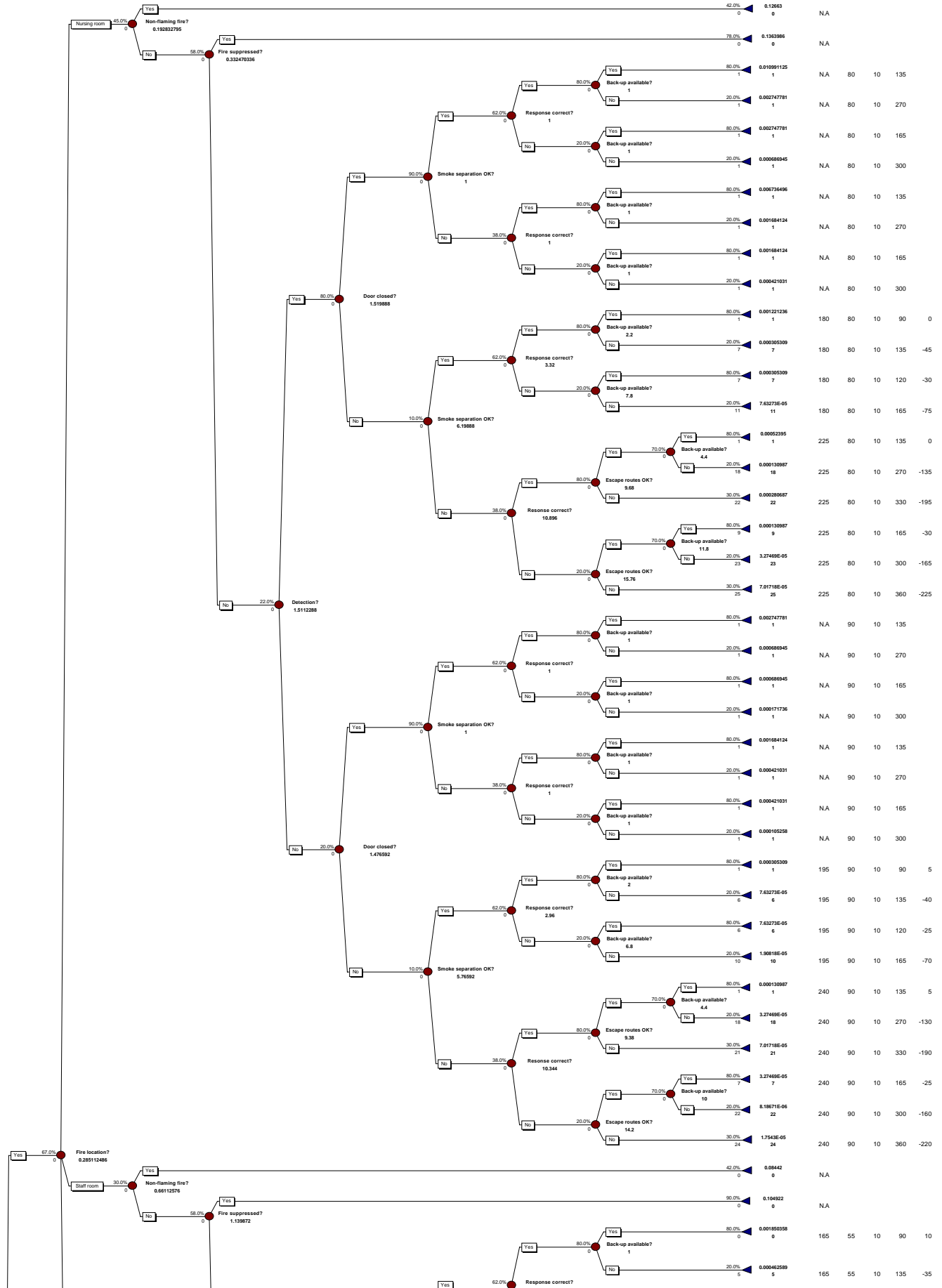

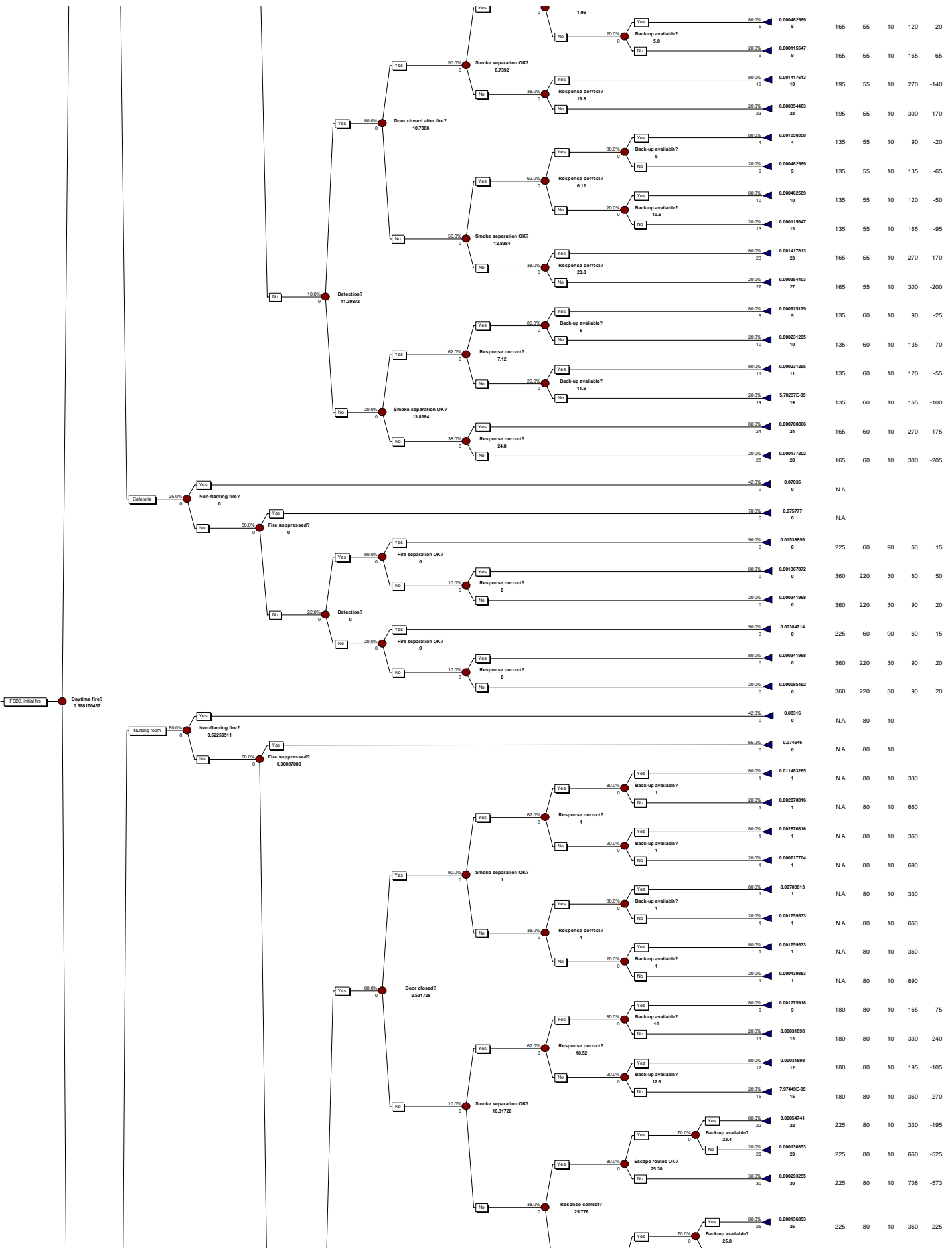

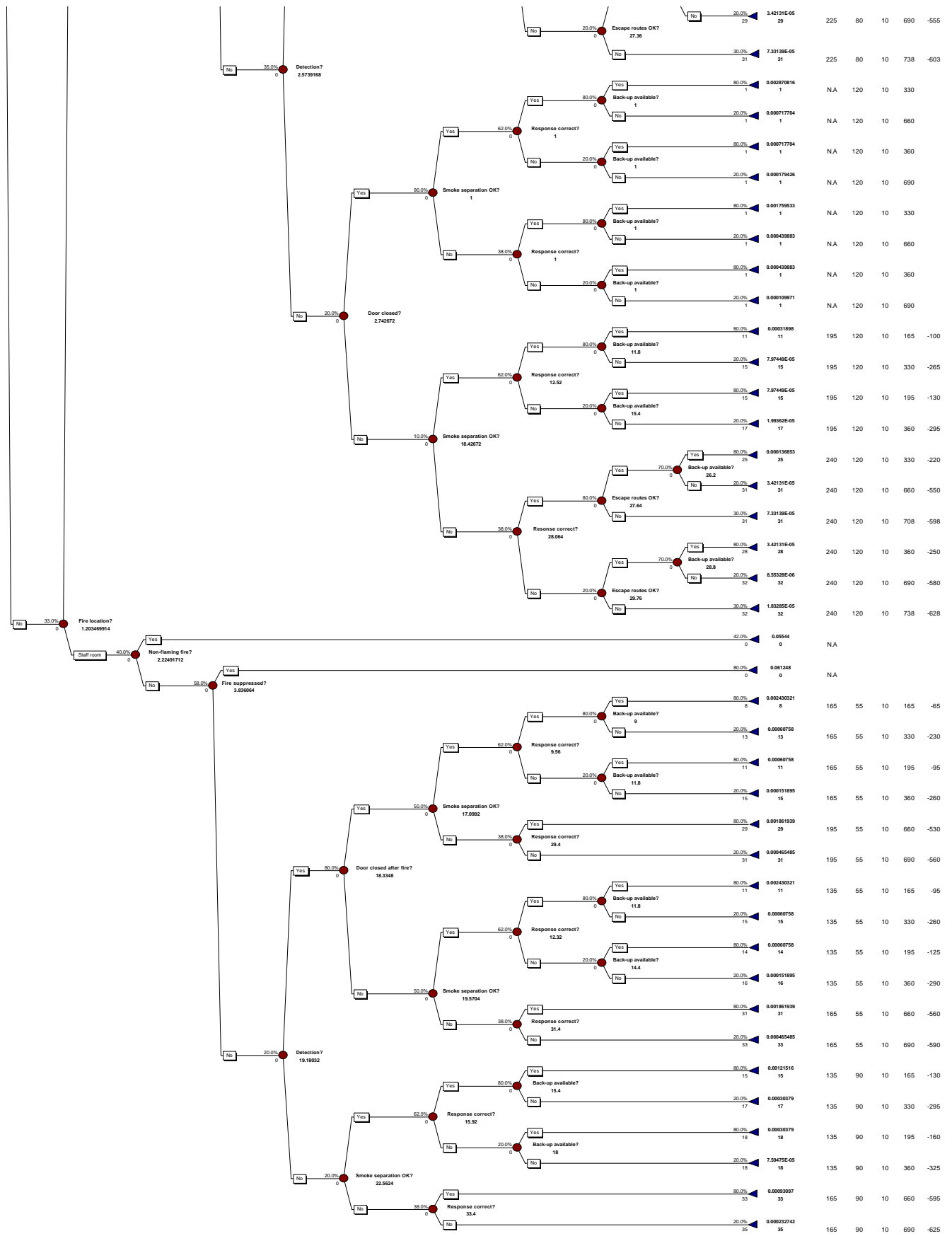

C Fire Development and Evacuation Calculations

This appendix presents fire development and evacuation calculations for a number of sub-scenarios. The aim of this appendix is to illustrate how the calculations have been performed. In the qualitative design review (Chapter 6) three different fire scenarios and fire safety designs were presented.

Fire scenarios

- The nursing room fire
- The staff room fire
- The cafeteria fire

Fire safety design

- FSD1 (standard protection)
- FSD2 (active protection)
- FSD3 (alternative active protection)

C-1 FSD1 and the nursing room fire

FSD1 consist of smoke detectors placed throughout the ward and an alarm bell to notify the ward's occupants of the fire. The sub-scenario includes initial fire → daytime fire → nursing room fire → flaming fire → fire not suppressed → no detection → door closed → response correct → all escape routes available.

C-1.1 Fire development

The fire starts when a patient smoking in bed falls asleep. The fire continues to grow and when the room reaches 250-300 °C, the other beds in the room start to burn. The door to the patient room is closed after the patients have been evacuated. Automatic detection fails, resulting in a manual detection after 90 s. Figure C.1 illustrates CFAST outputs.

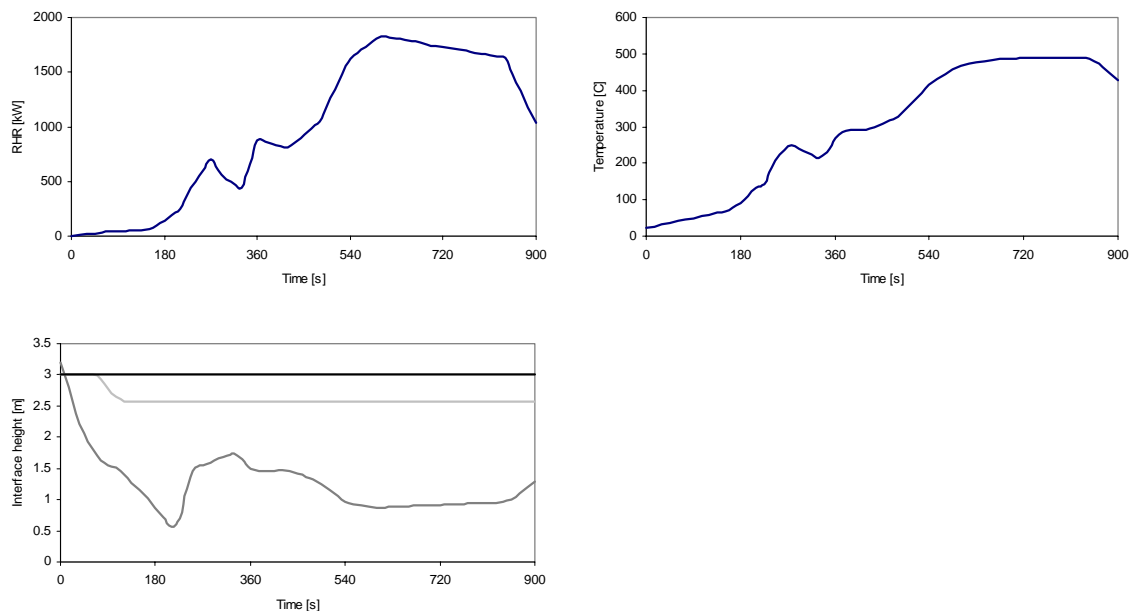

Figure C.1 The upper left figure shows the rate of heat release in the room. The upper right figure displays the temperature-time curve for the nursing room. The lower figure illustrates the interface height above the floor. The dark-grey line is valid for the nursing room and the other two for the corridor.

According to the CFAST simulations, critical conditions will only occur in the room of origin. The conditions in the corridor to which patients are evacuated will not be untenable. Critical conditions will occur in the nursing room after about 60 s.

C-1.2 Evacuation calculations

The detection time is estimated to be 90 s and the reaction time 10 s. The patients are assumed to be asleep and are therefore not aware of the growing fire. There is no chance that the patients in the room where the fire starts will be able to get out before untenable conditions occur. The equations used for travel time calculations are presented in chapter 7.

$$t_{\text{travel}} = (t_{\text{staffM}} + t_{\text{care}} + t_{\text{patM}} + t_{\text{queue}}) \times (N_{\text{pat}} / N_{\text{staff}}) - t_{\text{staffM}} \quad [7.2]$$

Table C.1 Values of the variables used in evacuation calculations.

t_{staffM}	10 s	t_{patM}	25 s
t_{care}	10 s	t_{queue}	N.A.
N_{pat}	36	N_{staff}	7

The travel time is then calculated to be 270 s. The total evacuation time is then 370 s.

C-1.3 Assessment vs. criteria

We use the design equation from Chapter 3

$$M = t_{\text{critical}} - t_{\text{detection}} - t_{\text{reaction}} - t_{\text{travel}} \quad [3.1]$$

If $M > 0$, the design solution is satisfactory

We will have a margin that is greater than zero for the corridor. But, for the nursing room the design equation gives a value of M that is less than zero, resulting in one person being exposed to critical conditions.

In summary, in this sub-scenario, the consequence is that one person is exposed to critical conditions. The probability of the sub-scenario is given in Appendix B, and has a value of 1.65×10^{-3} per year.

C-2 FSD2 and the cafeteria fire

FSD2 consists of sprinkler system designed to extinguish the fire and smoke detectors placed throughout the ward. The sub-scenario includes initial fire → daytime fire → cafeteria fire → flaming fire → fire not suppressed → detection → sprinkler successful → fire separation failures → response not correct.

C-2.1 Fire development

The fire is assumed to start in the deep-frying pan and to propagate to the adjacent kitchen equipment. The fire grows rapidly due to being a pool fire with pre-heated frying oil. Cupboards are quickly enveloped in the fire. The sprinkler activates after 200 s and the fire is detected after less than 60 s. Figure C.2 shows the CFAST outputs.

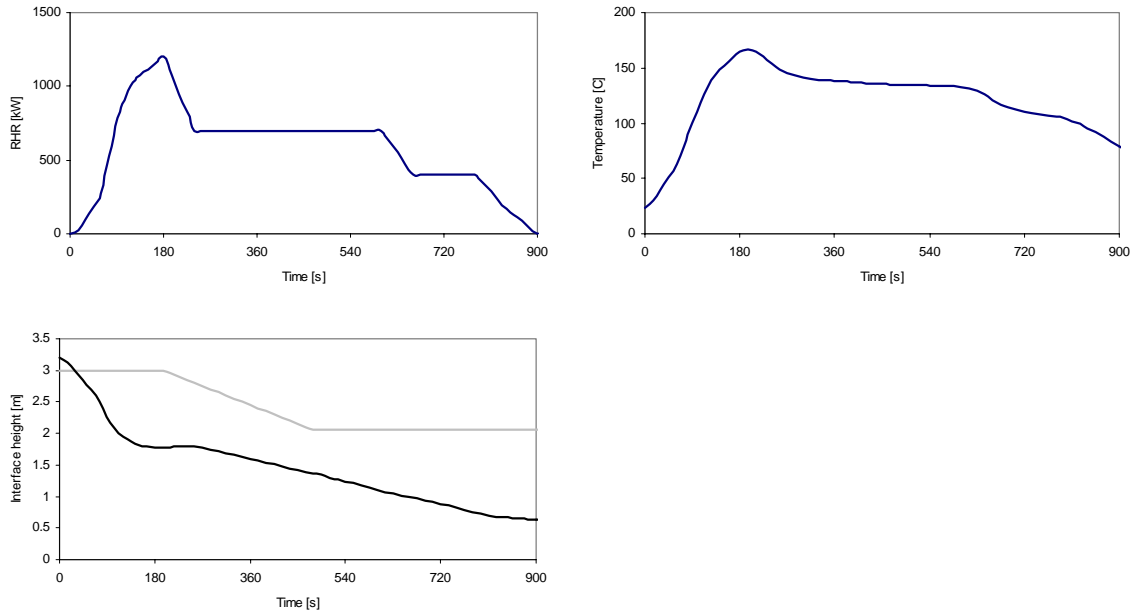

Figure C.2 The upper left figure shows the rate of heat release in the room. The upper right figure displays the temperature-time curve for the cafeteria. The lower figure illustrates the interface height above the floor. The light grey line denotes the medical care unit and the black line, the cafeteria.

Critical conditions will not occur in the medical care unit thanks to the activation of the sprinklers. In the cafeteria/entrance hall untenable conditions arise after 225 s.

C-2.2 Evacuation calculations

The detection time is estimated to be 60 s for the cafeteria/entrance hall and 220 s for the medical care unit. The reaction times are 90 s and 30 s, respectively. Patients in the unit are able to evacuate without the assistance of staff. Since critical conditions do not arise in the unit, evacuation calculations will only be performed for people in the cafeteria/entrance hall. The following equations from Chapter 7 are used.

$$t_{\text{queue}} = N_o / (W \times f) \tag{7.3}$$

$$t_{\text{travel}} = t_{\text{walk}} + t_{\text{queue}} \tag{7.4}$$

$$t_{\text{walk}} = D / v \tag{7.5}$$

Table C.2 Values of the variables used in evacuation calculations.

No	100 people	D	30 m
W	3 m	v	1.2 m/s
f	1 person / (m s)		

The travel time is then calculated to be less than 60 s., giving a total evacuation time of 210 s.

C-2.3 Assessment vs. criteria

Using the design Equation 3.1 to calculate the safety margin results in a positive outcome, i.e. the evacuation time is shorter than the time taken to reach untenable conditions. There will thus be no consequences to people in this sub-scenario.

C-3 FSD3 and the staff room fire

FSD3 consists of smoke and fire separation in the corridor, smoke detectors placed throughout the ward and an alarm system that notifies staff in adjacent wards so that they can assist in evacuation. The sub-scenario includes initial fire → night-time fire → staff room fire → flaming fire → fire not suppressed → detection → door not closed after fire → smoke separation OK → response not correct → back-up available.

C-3.1 Fire development

It is assumed that the fire starts in a malfunctioning coffee machine and spreads to nearby curtains. The fire grows rather quickly and the staff is not able to close the door. The detector activates after 55 s and the smoke separation doors close at the same time. Figure C.3 shows the CFAST outputs.

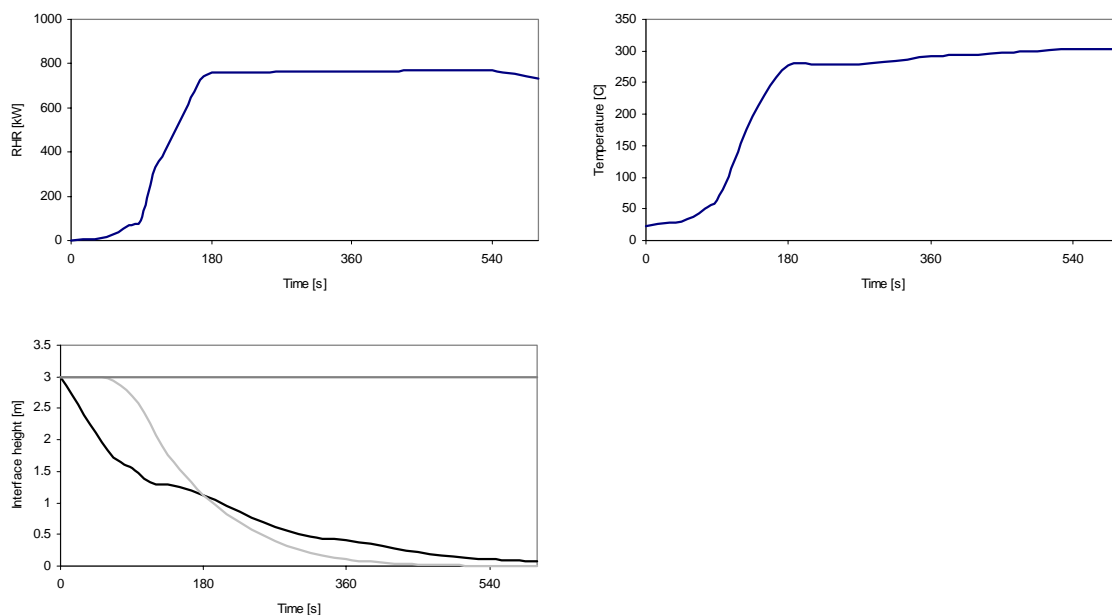

Figure C.3 The upper left figure shows the rate of heat release in the room. The upper right figure displays the temperature-time curve for the staff room. The lower figure illustrates the interface height above the floor. The grey lines denote the two corridors and the black line, the staff room.

Critical conditions will occur both in the staff room and in one of the corridors. The other corridor is unaffected, as the smoke separation is successful. The time taken to reach critical conditions in the corridor is 135 s.

C-3.2 Evacuation calculations

The automatic detection time is 55 s and the reaction time is 10 s. Using this information and the values presented in Table C.3, the travel time is calculated by using Equation 7.2.

Table C.3 Values of the variables used in evacuation calculations.

t_{staffM}	10 s	t_{patM}	25 s
t_{care}	20 s	t_{queue}	N.A.
No_{pat}	18	No_{staff}	6

Note that the number of patients has been changed to 18 as only half the ward is being evacuated in the first phase. The travel time is calculated to be 165 s, to which the extra 30 s should be added, because of incorrect staff response. The total evacuation time is 260 s.

C-3.3 Assessment vs. criteria

Using Equation 3.1 the safety margin is assessed to be minus 125 s. In order to calculate how many people will be exposed to untenable conditions, the following approach is used. If it takes the staff 165 s to move all the patients to the protected lobby and there is a lack of 125 s, patients are only evacuated during the first 40 s. By dividing the actual travel time (40 s) by the required travel time (165 s) and multiplying by the number of patients, it is possible to calculate the number of patient evacuated before critical conditions. In this case 4 patients are evacuated. The rest, 14 people, are thus exposed to critical conditions.

In summary, in this sub-scenario 14 people are exposed to critical conditions a the probability of 1.83×10^{-4} .